

DL-301/DL-302/DL-303

CO/ CO₂/Temperature/Humidity/Dew Point Data Logger User Manual



Version: 1.1.0

Date: Aug. 2015

Edited by Sunny Chiu

Warranty

All products manufactured by ICP DAS are warranted against defective materials for a period of one year from the date of delivery to the original purchaser.

Warning

ICP DAS assumes no liability for damages consequent to the use of this product. ICP DAS reserves the right to change this manual at any time without notice. The information furnished by ICP DAS is believed to be accurate and reliable. However, no responsibility is assumed by ICP DAS for its use, nor for any infringements of patents or other rights of third parties resulting from its use.

Copyright

Copyright © 2015 by ICP DAS. All rights are reserved.

Contact Us

If you have any questions, please feel free to contact us via email at:

Service@icpdas.com

Service.icpdas@gmail.com

Contents

1. Introduction	1
2. Hardware	6
2.1 Specifications	6
2.2 Appearance	8
2.3 Dimensions (unit: mm)	12
2.4 Cabling for Power and Network	13
3. Configuration via Touch Screen	15
3.1 Alarm & Temperature	17
3.2 DO & LCD	19
3.3 Date & Time	21
3.4 Data Logger	22
3.5 Ethernet	23
3.6 RS-485	25
4. Configuration via Web Browser	26
4.1 Search the DL-300 logger	26
4.2 Logging into the DL-300	27
4.3 Home	28
4.4 Network	30
4.5 MQTT	32
4.6 I/O Settings	36
4.7 Message	41
4.8 Accessible IP	43
4.9 Change Password	44
4.10 Logout	46
5. Configuration via RS-485	47
6. Monitoring via Mobile Devices	56
7. Utility to Get/Manage Data Log	57
8. FAQ	68
Q1: What is ABC (Automatic Baseline Correction)?	68
Q2: Why I need to enable the ABC?	68
Q3: Does the DL-302/DL-303 enable the ABC as the factory default setting?	68
Q4: What to do when the ABC is no work?	68
Q5: How to set the touch password?	69
Q6: How to cancel the touch password?	70
Q7: How to set the Accessible IP?	70

Q8: How to delete the Accessible IP settings?	71
Q9: How to clear the data logged in a DL-300 module?	71
Q10: How to calibrate the touch screen?	72
Q11: How to download firmware into a DL-300 module?	73
Q12: How to display message on the DL-300 with Modbus command?	75
Appendix A: DCON Command Sets	78
A-1. DL-301 DCON Command Sets	78
A-2. DL-302 DCON Command Sets	84
A-3. DL-303 DCON Command Sets	90
Appendix B: ModbusMasterToolPC	96
Appendix C: Modbus Address Table	100
C-1. DL-301 Modbus Address Mappings (Base 1)	100
C-2. DL-302 Modbus Address Mappings (Base 1)	107
C-3. DL-303 Modbus Address Mappings (Base 1)	113
Revision History	120

1. Introduction

The DL-300 series is a data logger designed to accurately measure and record the concentration of carbon monoxide/carbon dioxide in the atmosphere, temperature and humidity. It can display the real-time data and log the concentration of CO, CO₂, temperature and humidity with a date and time stamp for downloading later. The logging interval is programmable and up to 450,000 data points can be stored in built-in, non-volatile memory.

Users can configure a DL-300 module from the touch screen or via a regular web browser when the module and PC are both connected to the same switch or Ethernet segment. With free iAir app on users' iOS or Android phones or tablets, they can get the real data over a Wi-Fi network anytime and anywhere. The free DL300 Utility is a convenient software tool to get the real-time data, show run charts and download data from multiple devices running on Windows platform.

The DL-300 series contains RS-485, Ethernet and PoE communication interfaces, the most common communication interfaces in industrial network. It supports a wide operating temperature range of 0 ~ 50°C and easy to be installed by placing on a horizontal surface such as a desktop, mounted on a DIN-rail, or mounted on the wall.



Characteristics

- ▶ Simultaneous display for CO/CO₂ level, temperature, humidity and dew point
- ▶ CO measurement range: 0 ~ 1000 ppm
- ▶ CO₂ measurement range: 0 ~ 9999 ppm
- ▶ Non-dispersive Infrared (NDIR) sensor with Automatic Baseline Correction algorithm for CO₂ measurement
- ▶ Able to store up to 450,000 records
- ▶ 2.8" LCD touch screen with resolution of 240 x 320 x 16
- ▶ Supports displaying multilingual messages
- ▶ Remote control with a standard web-browser
- ▶ iAir App for iOS or Android mobile devices to monitor on-line data
- ▶ Supports the DCON, Modbus RTU, Modbus TCP and MQTT protocols
- ▶ One relay output for turning on/off alarm light/buzzer or IAQ control devices
- ▶ Includes RS-485/Ethernet/PoE communication interfaces
- ▶ Desktop, DIN-Rail or wall mounting
- ▶ Wide operating temperature range of 0 ~ 50°C
- ▶ RoHS compliant with no Halogen

Features

▶ NDIR Sensor

NDIR (Non-Dispersion Infrared) is based on one of the natural properties of CO₂ molecules: CO₂ molecules absorb light at a specific wavelength of 4.26 μm. This wavelength is in the infrared (IR) range. High concentrations of CO₂ molecules absorb more light than low concentrations. NDIR sensor can detect fast and accurately in a wide range of CO₂ concentration.

▶ Built-in Web Server

With the built-in Web server, users can easily log in to the DL-300 module via a standard web browser to monitor the data and configure the settings without install any software in the terminal.

▶ Get Real-time Data Anywhere and Anytime

iAir App for iOS or Android Phones or Tablets is free and easy to install, it can obtain the real-time data from DL-300 modules over a Wi-Fi network anytime and anywhere. The iAir App can link to the DL-300 modules by specifying IP addresses or by searching all the modules connected to the same Ethernet segment.



► Data Logging Software

The DL300 Utility can be used to configure the modules, monitor real-time data and show the run chart, log alarm events, group DL-300 modules so that the status of distribution groups can be viewed and managed. The utility also allows the log data to be downloaded and exported to a .CSV file that can then be imported into any industry-standard software or spread sheet for analysis.

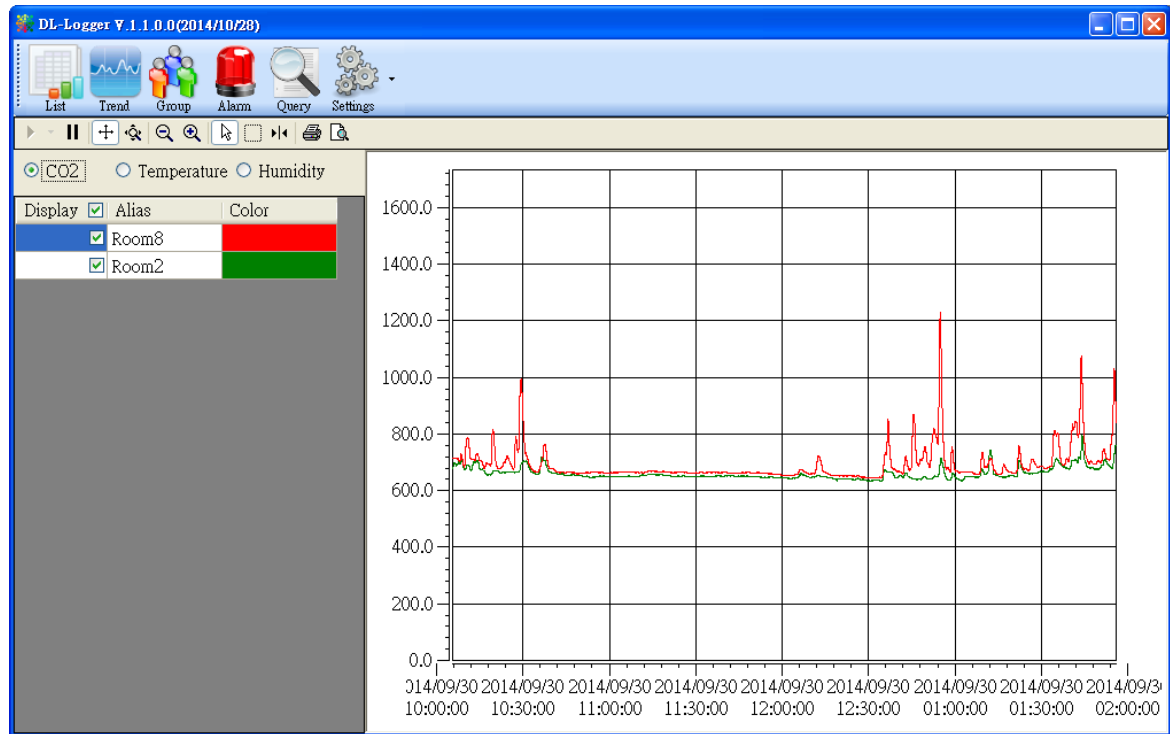

► Easy integration with SCADA software

Modbus is one of the most popular protocols used in the industrial world. Supporting traditional serial protocols of RS-485 and Ethernet protocols allow the DL-300 series well-integrated into the HMI/SCADA systems.

► Alarm

DL-300 series allows users to set high alarm level for CO/CO₂/ Temperature/Humidity/Dew Point and low alarm level for Temperature/Humidity/Dew Point, and to enable/disable the alarm functions. An Alarm LED indicator on the front of the DL-300 module will flash when an alarm event is activated, and a relay output related to all alarm events can be use to tap an alarm light/sound or control the IAQ devices such as ventilators, air cleaners, and filters. Beep alarm is available when the CO/CO₂ high level alarm occurs.

▶ **Screen Lock**

Users can secure a DL-300 module by setting a screen lock via the web interface. If the lock is set, users need to enter the correct password when they would like to configure the DL-300 module.

▶ **Automatic Baseline Correction**

The built-in ABC algorithm makes the CO₂ sensor on the DL-302 and DL-303 maintenance-free. In most indoor applications, the carbon dioxide level drops to nearly outside air - 400 ppm, and then the ABC algorithm constantly keeps track of the lowest reading and slowly corrects it as the expected fresh air value of 400 ppm.

The ABC algorithm can not apply for the places where are no periods that the CO₂ concentration drops to background level such as greenhouses, hospitals, 24-hour operation factories or stores. The ABC function needs be disabled where the spaces the CO₂ concentration may be elevated at all times.

▶ **Easy Wiring**

Support for RS-485, Ethernet and Power over Ethernet (PoE) interfaces for users to choose the appropriate one to meet the field requirements.

▶ **Power over Ethernet (PoE)**

The DL-300 series features true IEEE802.3af-compliant (classification, Class 1) PoE technology that allows both power and data to be carried over a single Ethernet cable. PoE provides a unified power system, as well as backup provisions for critical building functions, without any additional cables, outlets or connections. It can reduce the power supply wiring and maintenance costs, and improve system scalability.

▶ **Support for MQTT protocol**

MQTT is a protocol designed for the efficient exchange of real-time data with sensor and mobile devices. It runs over TCP/IP and is in widest use on the "machine-to-machine" (M2M) and "Internet of Things" applications today

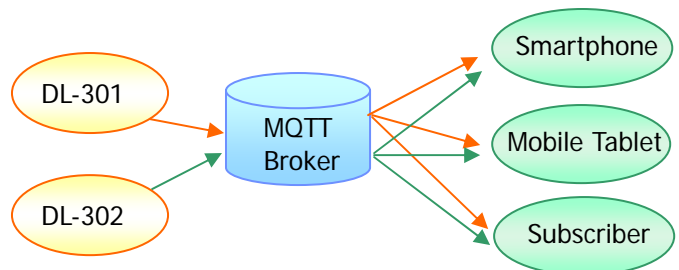

► Display Multilingual Messages on Screen



The display message function supports multilingual character sets in UTF-8 encoding. Users can remotely display pre-saved messages or dynamic messages by Modbus commands, or send a dynamic message through the web interface.

A message is limited to six lines maximum and 14 half-width characters or 7 full-width characters maximum each line.

2. Hardware

2.1 Specifications

Model	DL-301	DL-302	DL-303
CO Measurement			
Range	0 to 1000 ppm (Electrochemical)	-	0 to 1000 ppm (Electrochemical)
Resolution	1 ppm	-	1 ppm
Accuracy	±5% of measured value	-	±5% of measured value
Response Time	30 seconds	-	30 seconds
Warm-up Time	60 seconds	-	60 seconds
CO₂ Measurement			
Range	-	0 ~ 9999 ppm	
Resolution	-	1 ppm	
Accuracy	-	±30 ppm ±3%	
Response Time	-	20 seconds	
Warm-up Time	-	60 seconds	

Temperature Measurement				
Range	-10 ~ +50°C			
Resolution	0.1°C			
Accuracy	±0.6°C			
Relative Humidity Measurement				
Range	0 ~ 100% RH, Non-condensing			
Resolution	0.1% RH, Non-condensing			
Accuracy	±5% RH, Non-condensing			
Dew Point				
Range	Calculated using temperature and relative humidity			
Resolution	0.1°C			
System				
CO Alarm	Yes	-	Yes	
CO ₂ Alarm	-	Yes	Yes	
Real Time Clock	Yes			
Data Logger	Yes, 450,000 Records			
Alarm Relay Output	Form A x1, SPST. 30 VDC @ 16 A or 250 VAC @ 16 A 30 VDC @ 16 A or 250 VAC @ 16 A			
Network Interface	RS-485/Ethernet/PoE			
Main Machine Interface				
Touch Screen	2.8" TFT (Resolution: 240 x 320 x 16), Defective Pixels <= 3			
Backlight Life	20,000 hours			
Brightness	160 cd/m ²			
Electrical				
Powered via Terminal Block	+12 ~ +48 VDC			
Powered via PoE	IEEE 802.3af, Class 1 (require a PoE switch or injector)			
Power Consumption	PoE	1.84 W (Max.)	2.65 W (Max.)	2.83 W (Max.)
	Non-PoE	1.74 W (Max.)	2.14 W (Max.)	2.24 W (Max.)
Mechanical				
Dimensions (W x L x H)	106 mm x 114 mm x 56 mm			
Installation	Desktop, DIN-Rail or Wall Mounting			
Environment				
Operating Temperature	0 ~ +50°C			
Storage Temperature	-30 ~ +75°C			
Humidity	10 ~ 90% RH, Non-condensing			



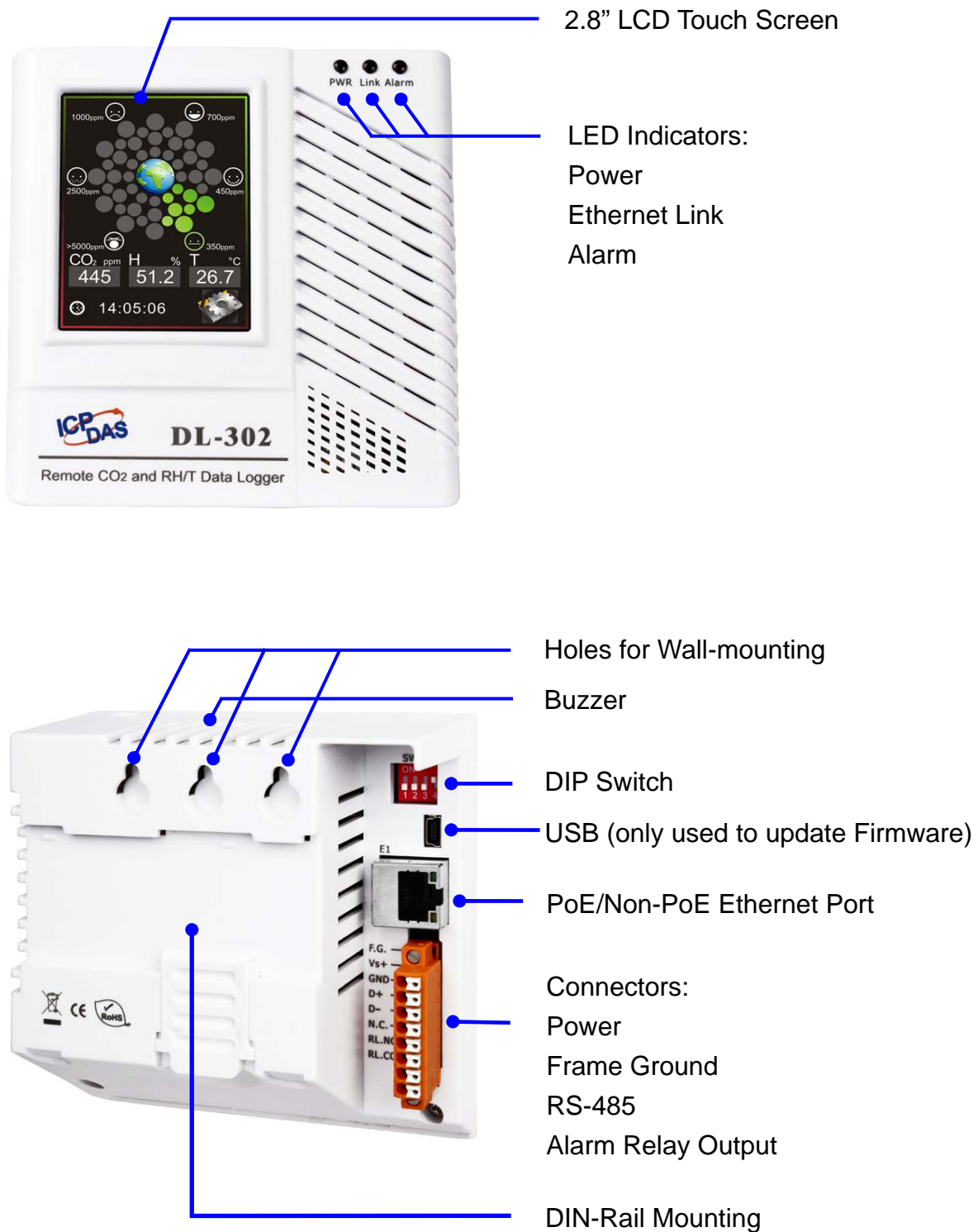



2.2 Appearance









2.8” LCD Touch Screen

The DL-300 series is equipped with a touch screen user interface that allows access to the configuration in the module. The center of the screen shows chart from green to red to represent the concentration of CO/CO₂ from low to high:

For CO

↑ ppm	
	200 Slight headache within 2 to 3 hours, loss of judgment
	100 Slight headache in 2 to 3 hours
	50 Headache and dizziness within 6 to 8 hours
	10 Unhealthy for sensitive groups
	5 Average level in homes
	0 Natural atmosphere level

For CO₂

↑ ppm	
	5000 Do not stay in the level over 8 hours
	2500 Headache, dyspnea and adverse health effects
	1000 Dizziness
	700 Complaints of poor air
	450 Acceptable level
	0 Healthy, (normal) outdoor air level

The CO/CO₂ concentration, temperature, humidity, dew point, alias name, date and time are displayed in turn on the bottom left-hand side of the screen.

Touch the icon



at the bottom-right corner of the screen to enter the **Settings** menu.

LED Indicators

The three LED indicators from left to right are:

- ▶ PWR: green for normal operation.

The PWR LED indicator flashes when the module is searched in the list of iAir App and the icon  is tapped for easier checking which module is the one in the list.

- ▶ Link: green for the Ethernet linked.
- ▶ Alarm: red for alarm condition.

DIP Switch



The functions are printed on the top beside the SW1 DIP switch. All the 4 dip switches need be turned to the off position for normal operation.

1. Reserved
2. FW Update: ON for updating firmware.
3. Touch Calib: ON for touch screen calibration.
4. INIT: ON for using the factory default settings for communication

USB

The USB port is used to update firmware only.

PoE/ non-PoE Ethernet port

The Ethernet port can be used to connect to a PoE switch or a non-PoE switch.

Connector for Power/ Frame Ground / RS-485/ Alarm Relay Output

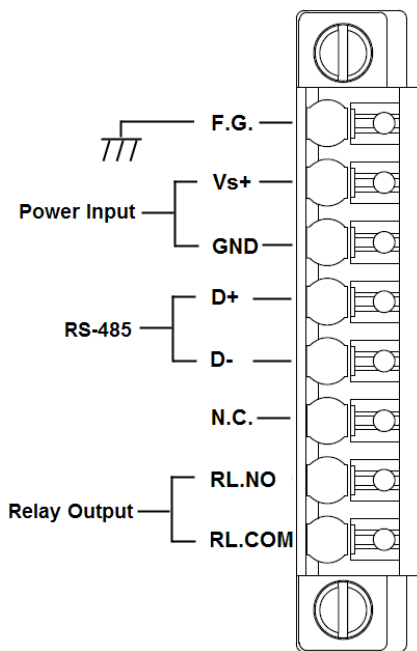

The Push-in connector can easily connect and detach solid wires or wires with wire-end ferrules without using tools. Just push in the solid wire to lock it and press the white button to release the wire.

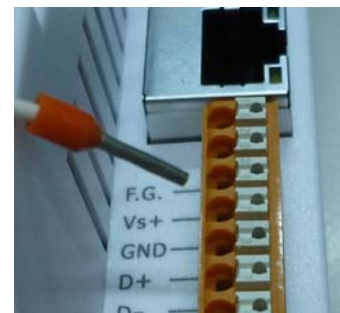
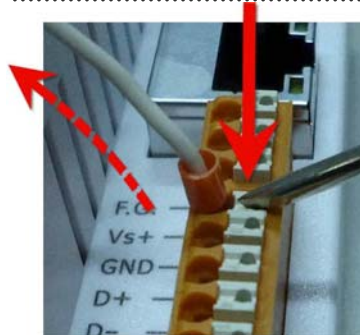

- Wire requirement:
- Stripping length: 8 ~ 10 mm
 - 0.20 - 1.5 mm² (IEC) / 28 - 16 AWG (UL)

Relay Output Wire Connection

Output Type	ON State Readback as 1	OFF State Readback as 0
Relay Output	<p>A circuit diagram showing an AC/DC power source connected to a load. The load is connected to the RLx NO (Normally Open) and RLx COM (Common) terminals of a relay. The circuit is closed, allowing current to flow through the load.</p>	<p>A circuit diagram showing an AC/DC power source connected to a load. The load is connected to the RLx NO and RLx COM terminals of a relay. The circuit is open, preventing current from flowing through the load.</p>

2.3 Dimensions (unit: mm)

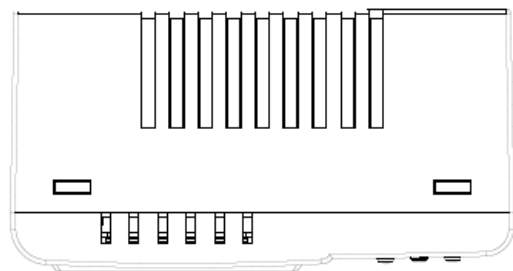
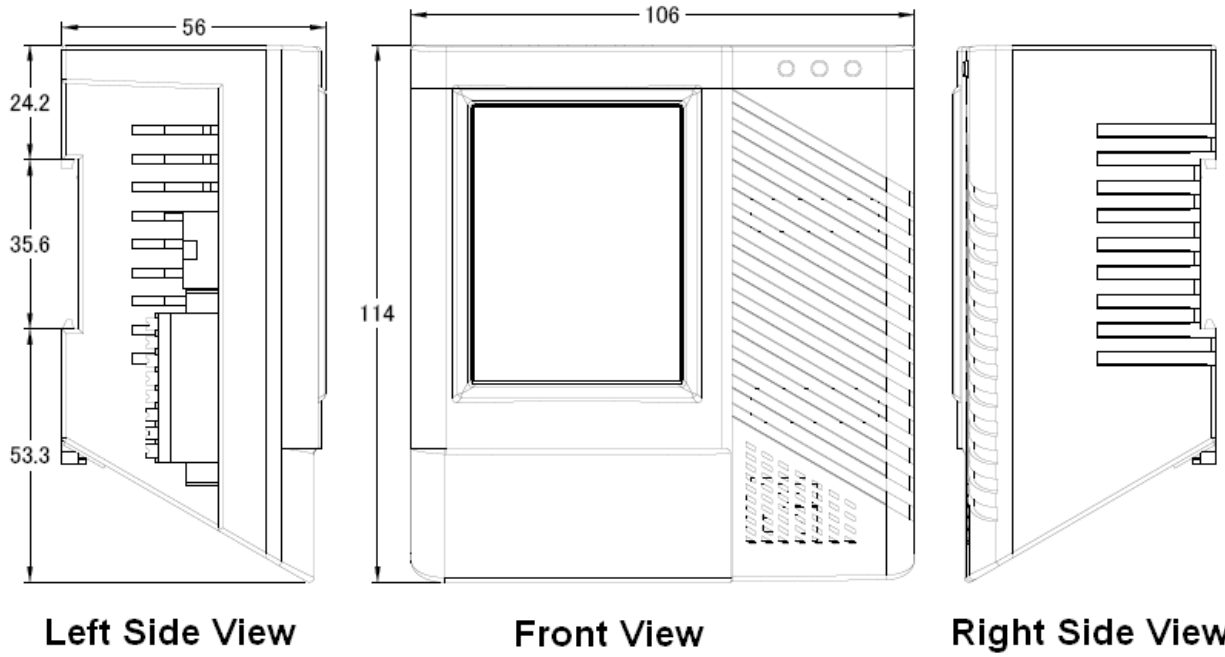

Top View

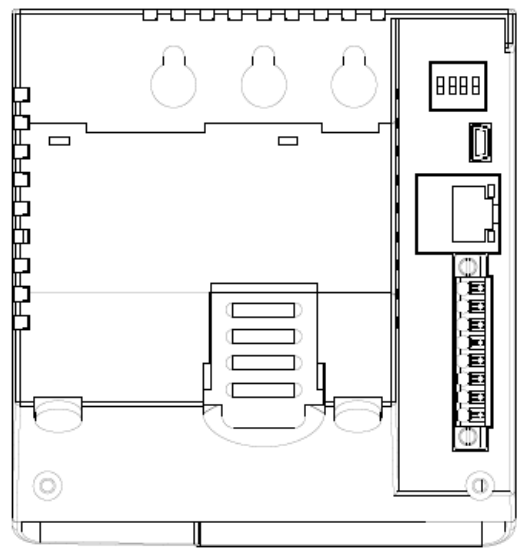

Rear View

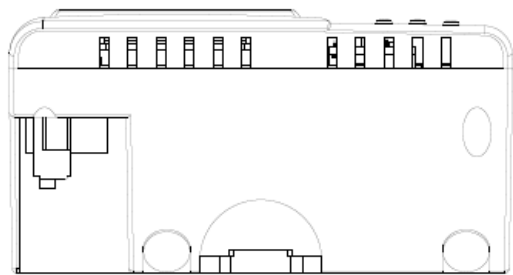

Bottom View

2.4 Cabling for Power and Network

Note

- Do not install the DL-300 module near a vent, a ventilation fan or a door where the air flows faster. Also avoid putting the module on a desktop below the nose and mouth to prevent incorrect measurement.
- Avoid installing in locations where the temperature is below 0°C or above 50°C.
- Avoid installing in locations near a strong electromagnetic field.

For connecting with a PC or a Android device

The DL-300 logger can connect to a PoE network without a power source or connect to a non-PoE network. When using the **Search** function in iAir App on Android or iOS mobile devices, mobile devices need to connect to the same subnet that the DL-300 connected to over Wi-Fi. Similarly to using the Search function in DL-300 Utility running on Windows, the module and the host PC need to connect on the same subnet, too.

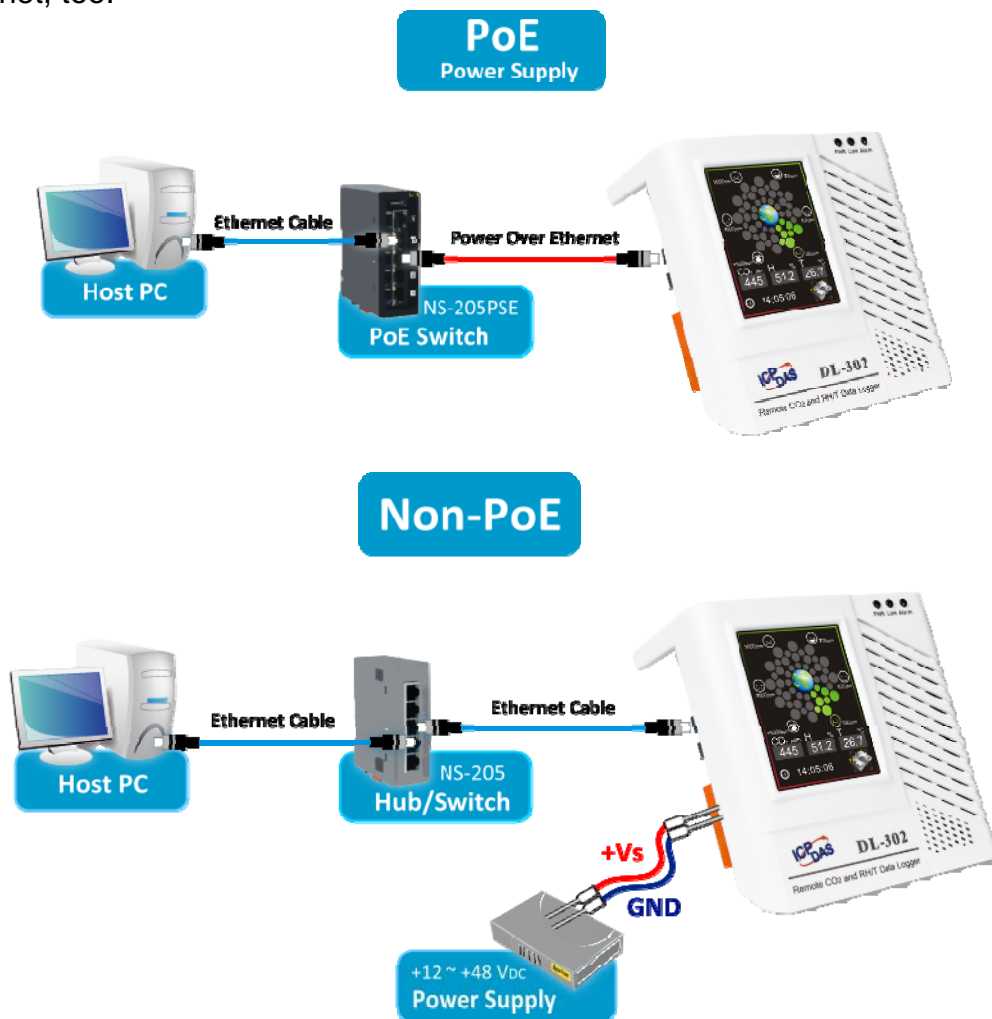

The iAir App and DL-300 Utility search the logger by broadcast, therefore only the devices on the same subnet can be searched out. It means that the host PC, Android devices and the logger must have the same broadcast address. The broadcast address for an IPv4 device can be obtained by performing a bitwise OR operation between the bit complement of the subnet mask and the IP address for a device. In other words, take the device's IP address, and set to '1' any bit positions which hold a '0' in the subnet mask.

For example, in an entire IPv4 subnet, the host PC or the Android device uses the private IP address space 172.16.0.0/12 and subnet mask address 255.240.0.0, the broadcast address is $172.16.0.0 \mid 0.15.255.255 = 172.31.255.255$. Only the loggers which have the same broadcast address could be searched out in the iAir App or DL-300 Utility. Please contact with your network administrator to make sure the DL-300 logger is connected to the same sub-network that your Android devices or PC is connected to.

For connecting with PC via RS-485 network

The DL-300 logger can connect to the PC through a RS-485 network with power input requirement of +12 ~ +48 V_{DC}.

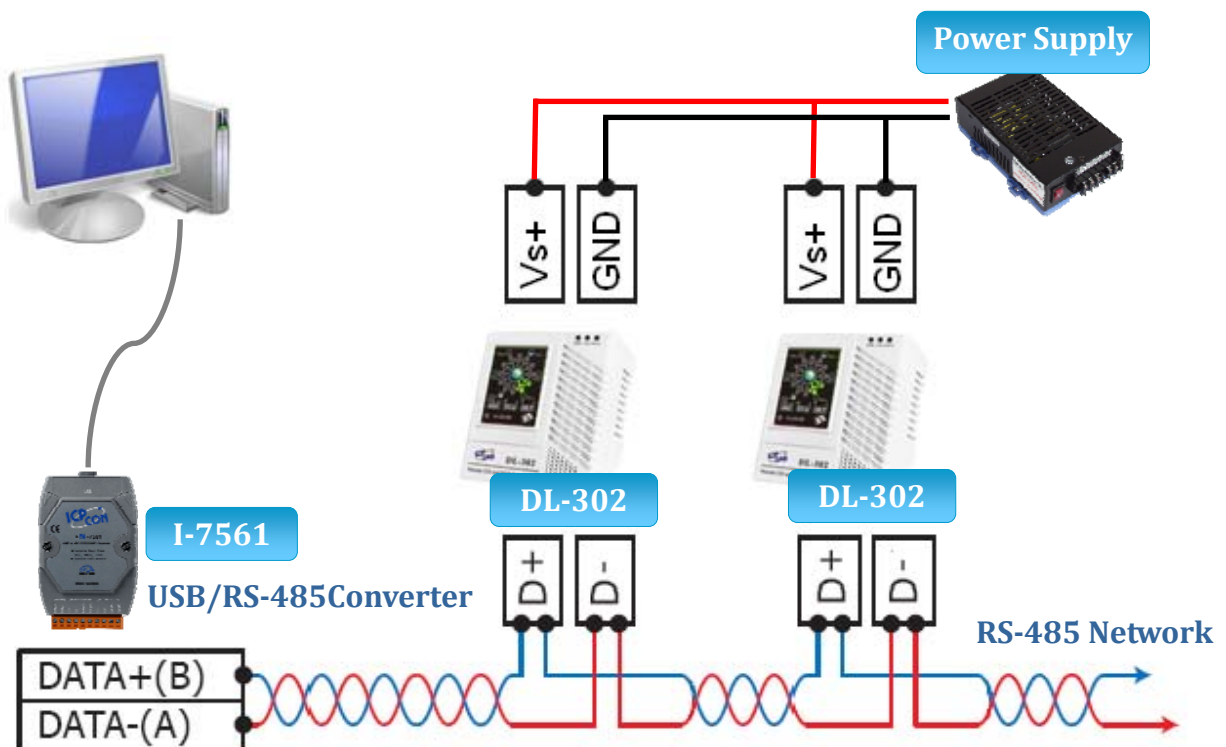

3. Configuration via Touch Screen

Home screen of DL-300 logger:

CO/CO₂

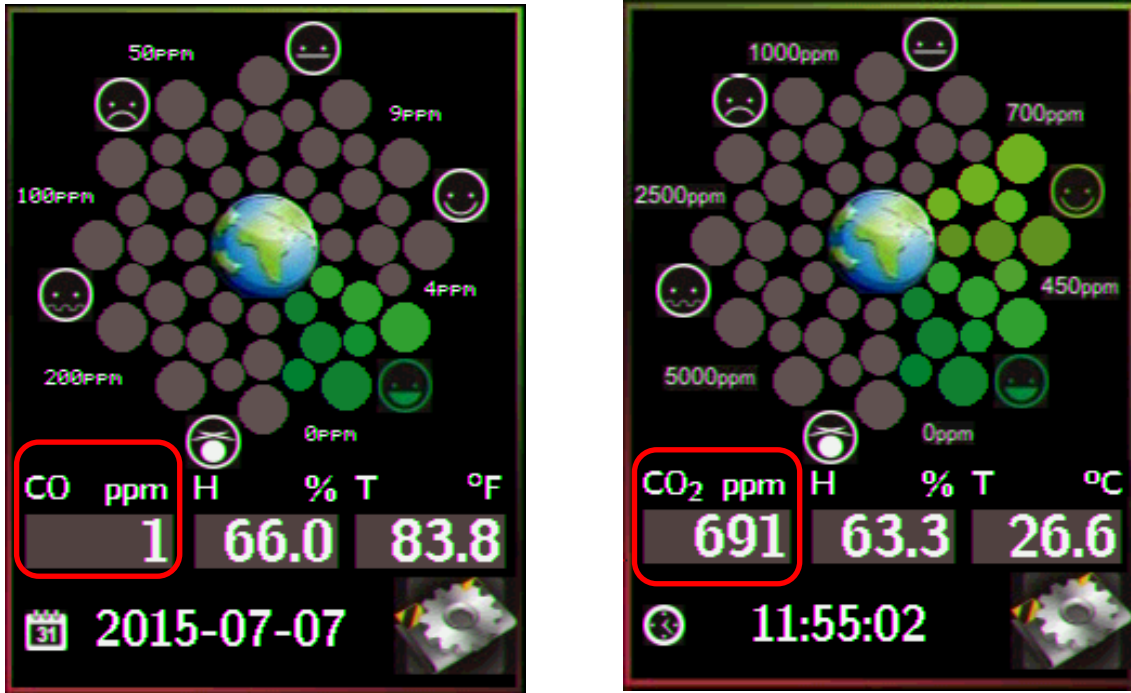

According to the concentration of CO/CO₂ in the air from low to high, the illustration at the center of screen shows from green to red:

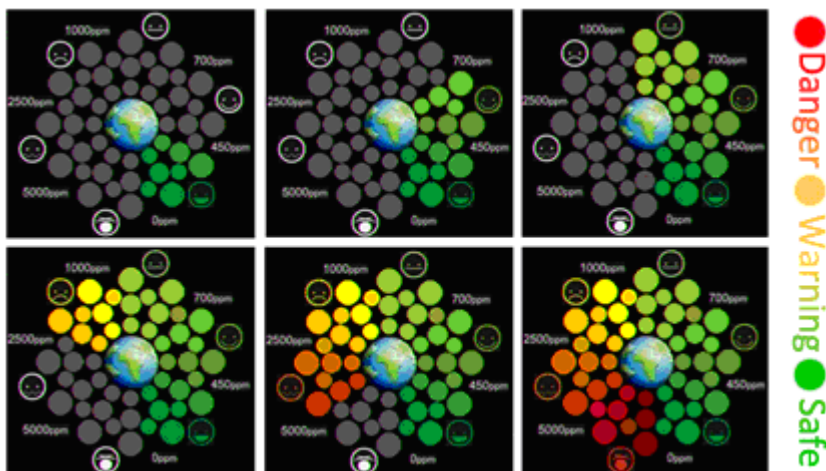

Touch the icon



in the bottom-right corner of screen to enter the Settings menu

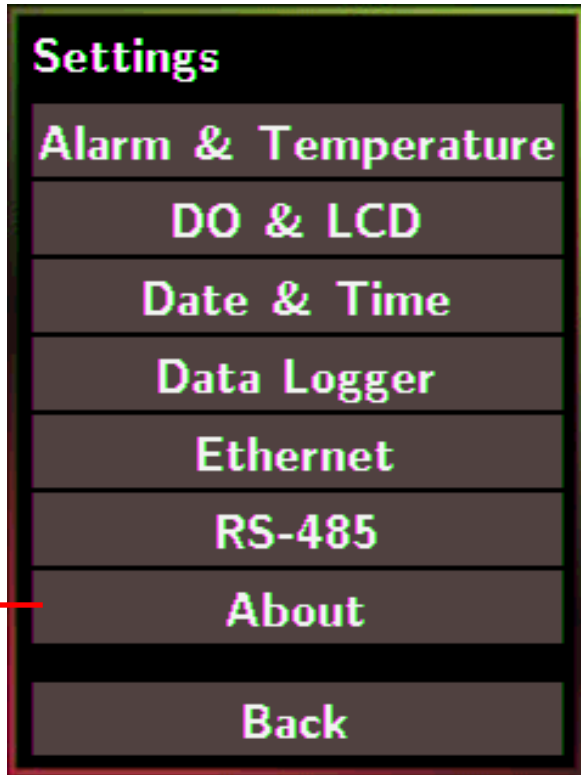

About : Information about the unit

The information including:

- Model Name: DL-301/DL-302/DL-303
- Alias Name: The user-defined name for identifying a DL-300 more easily.
- Firmware Version: The data and version for the firmware
- IP Address: The IP address for the logger
- MAC Address: The MAC address for the logger

Back : Back to Home Screen

Note

- The DL-300 logger comes with a resistive touch screen which senses input from contact with nearly any object such as finger, stylus/pen or hand with gloves.
- Touching the < or > symbol beside a value can increase or decrease the value by one. Long-pressing the < or > symbol beside a value can change the value more quickly. Similarly touching the << or >> symbol beside a value can increase or decrease the value by 100.

3.1 Alarm &Temperature

Tap the Alarm &Temperature item in the Settings menu to enter the sub-menu.

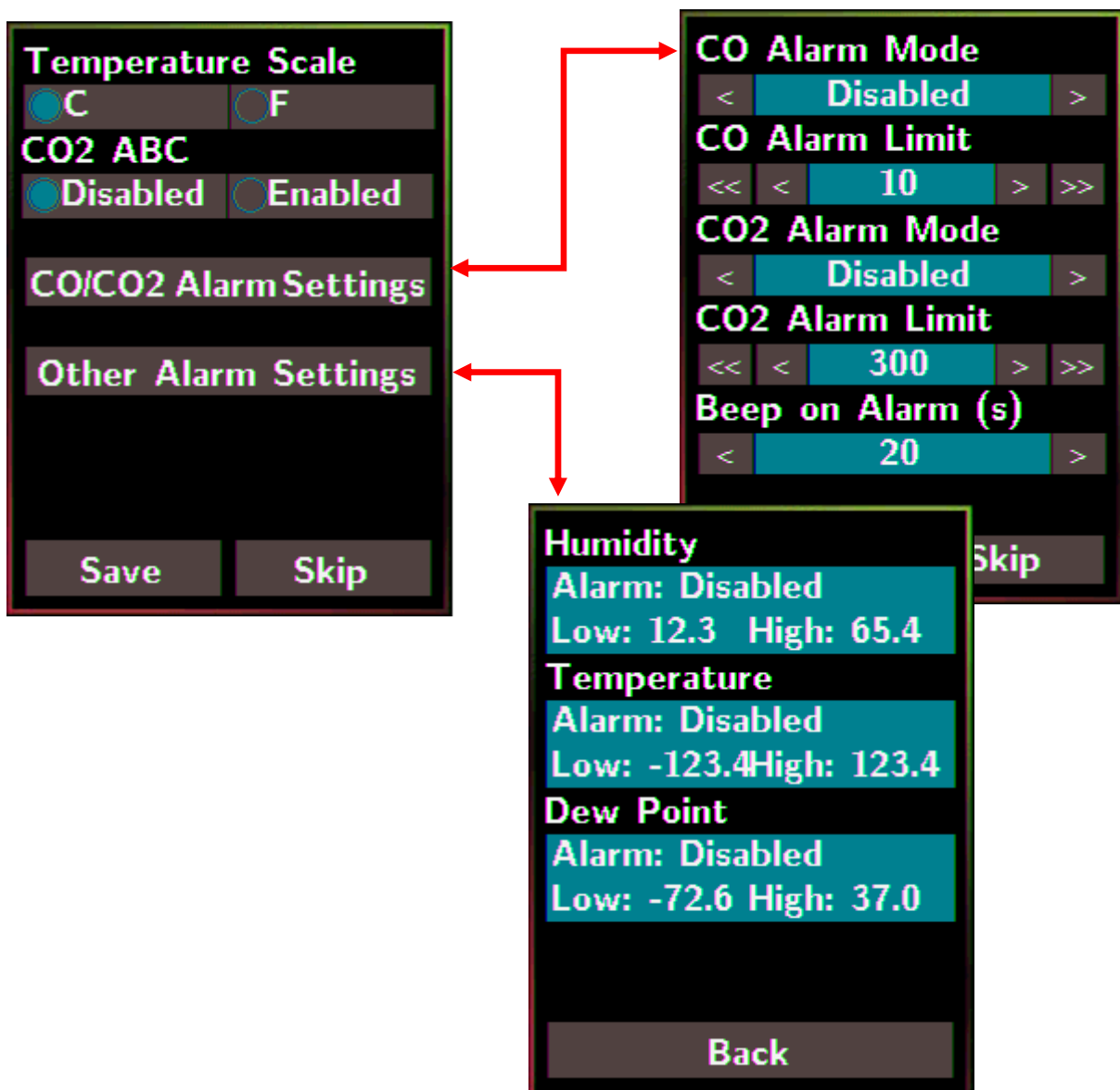

Temperature Scale:
<ul style="list-style-type: none"> - °C (default) - °F
CO2 ABC: (for DL-302/DL-303 only)
<ul style="list-style-type: none"> - Disabled: disables the CO₂ ABC function (default) - Enabled: enables the CO₂ ABC function
CO/CO2 Alarm Mode:
<ul style="list-style-type: none"> - Disabled: disables the alarm function (default) - Momentary: <ul style="list-style-type: none"> • When the CO/CO₂ level goes higher than the value set in CO/CO2 Alarm Limit, the Alarm LED lights red, the buzzer beeps as the setting in Beep on Alarm(s), and the relay outputs ON signal which can be used to turn on the user's alarm device. • When the CO/CO₂ level turns to lower than the value set in CO/CO2 Alarm Limit, the Alarm LED turns off; the relay outputs OFF signal. - Latched: <ul style="list-style-type: none"> • When the CO/CO₂ level goes higher than the value set in CO/CO2 Alarm Limit, the Alarm LED lights red, the buzzer beeps as the setting in Beep on Alarm, and the relay outputs ON signal which can be used to turn on the user's alarm device. • When the CO/CO₂ level turns to lower than the value set in CO/CO2 Alarm Limit, the Alarm LED keeps red and the relay keeps ON till the alarm status is cleared manually.
CO/CO2 Alarm Limit: Sets the high alarm level limit of CO/CO ₂ concentration
<ul style="list-style-type: none"> - CO Alarm Limit <ul style="list-style-type: none"> • Default: 50 ppm • Range: 0 ~ 1000 ppm - CO2 Alarm Limit <ul style="list-style-type: none"> • Default: 1000 ppm • Range: 0 ~ 10000 ppm
Beep on Alarm: the alarm keeps beeping with setting for Beep on Alarm(s) in seconds. The beep alarm is for High CO/CO ₂ alarm only.
<ul style="list-style-type: none"> - Continuously: continues beeping without stop (default) - Disabled: disables the beep alarm - 1~250: sets the time for beep alarm in seconds.

Other Alarm Settings: Displays the alarm mode and high/low alarm limit settings for Humidity, Temperature and Dew Point. Parameters on this page can be set through web interface or Modbus/DCON commands.

- Alarm: Alarm mode, disabled by default.
- Low: low alarm limit settings
- High: high alarm limit settings

Save: Saves the modification and returns to the Settings menu.
All the changes take effect immediately after saving changes.

Skip: Returns to the Settings menu without saving any changes.

3.2 DO & LCD

Tap the DO & LCD item in the Settings menu to enter the sub-menu.

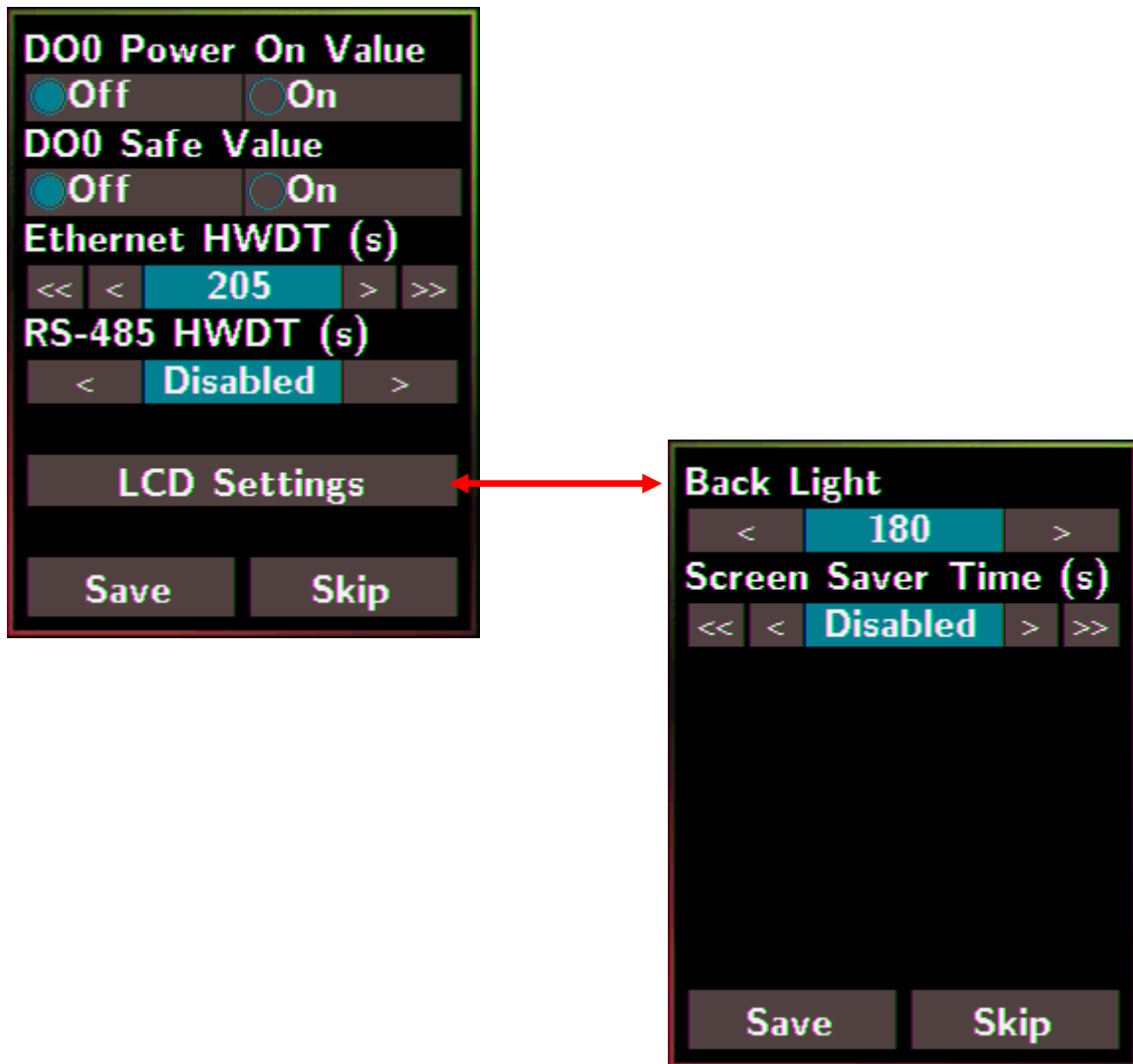

<p>DO0 Power On Value: Sets the relay output status when the DL-300 is powered on. It is invalid when the any one alarm mode for CO/CO₂/Humidity/Temperature/Dew Point in Alarm &Temperature sub-menu is not disabled.</p>
<p>Default: Off</p>
<p>DO0 Safe Value: Sets the status of relay output when the Ethernet HWDT or RS-485 HWDT timeout occurs. The default setting is that a user needs to clear the timeout status and then he can control the DO again; alternatively it can be set to control the DO again without clear the timeout status by Modbus command. (Address: 00260) It is invalid when the any one alarm mode for CO/CO₂/Humidity/Temperature/Dew Point in Alarm &Temperature sub-menu is not disabled.</p>
<p>Default: Off</p>
<p>Ethernet HWDT: Enables/Disables the Ethernet Host Watchdog Timer. The Ethernet HWDT timeout will occur if the host does not visit the DL-300 through the Ethernet network in the time period of setting for Ethernet HWDT, then the DO0 will output the safe value. The DO0 save value is invalid when the any one alarm mode for CO/CO₂/Humidity/Temperature/Dew Point in Alarm &Temperature sub-menu is not disabled.</p>
<ul style="list-style-type: none"> • Default: Disabled • Range: 5 ~ 65535 (unit: seconds)
<p>RS-485 HWDT: Enables/Disables the RS-485 Host Watchdog Timer. The RS-485 HWDT timeout will occur and DO0 will output the safe value if the host does not communicate with the DL-300 through the RS-485 network in the time period of setting for RS-485 HWDT. It is invalid when the any one alarm mode for CO/CO₂/Humidity/Temperature/Dew Point in Alarm &Temperature sub-menu is not disabled.</p>
<ul style="list-style-type: none"> • Default: Disabled • Range: 0.1 ~ 25.5 (unit: second)
<p>LCD Settings: Sets the brightness of back light and the lapse time for screen saver operation.</p>
<p>Backlight:</p> <ul style="list-style-type: none"> • Default: 180 • Range: 0 ~ 255 <p>Screen Save Time (s)</p> <ul style="list-style-type: none"> • Default: 30 • Range: 0 ~ 65535 (unit: second), 0 = disables screen saver.

3.3 Date & Time

Tap the Date & Time item in the Settings menu to enter the sub-menu.

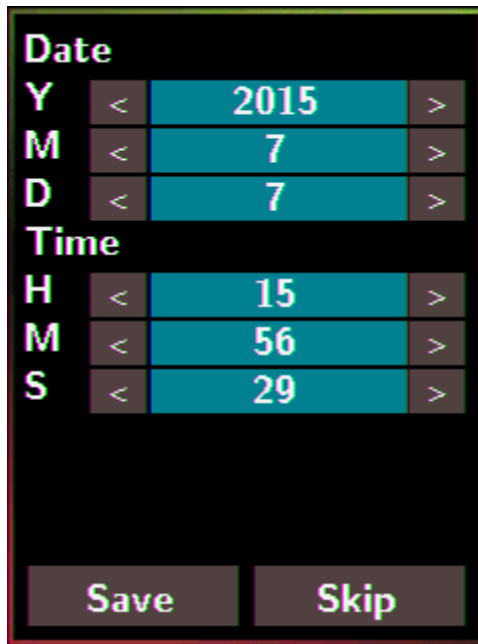

Y: Sets the year from 2000 to 2159
M: Sets the month from 1 to 12
D: Sets the data from 1 to 31
H: Sets the hour from 0 to 23
M: Sets the minute from 0 to 59
S: Sets the second from 0 to 59
Save: Saves the modification and returns to the Settings menu. All the changes take effect immediately after saving changes.
Skip: Returns to the Settings menu without saving any changes.

3.4 Data Logger

Tap the Data Logger item in the Settings menu to enter the sub-menu.

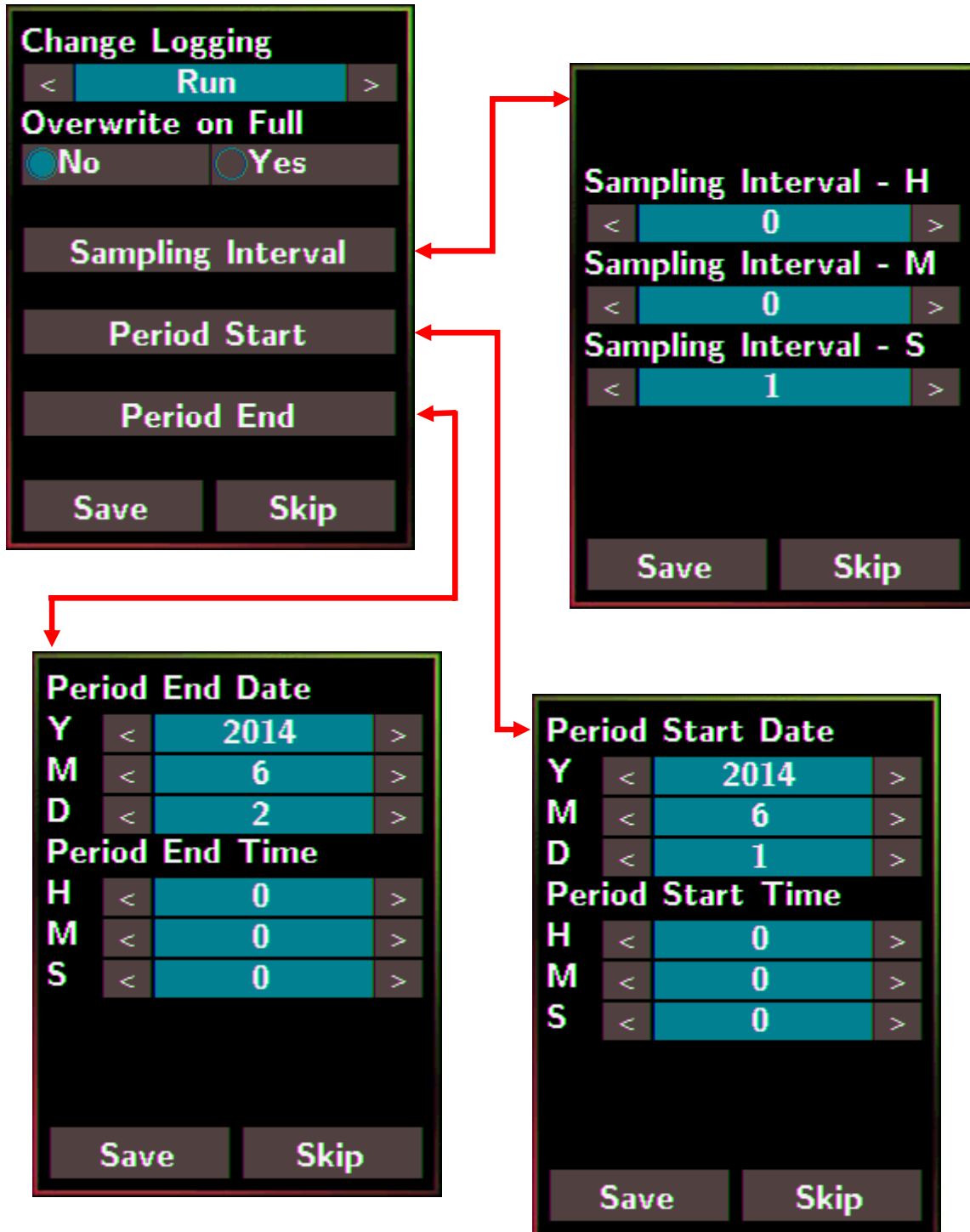

Change Logging: Sets the mode for data logger
<ul style="list-style-type: none"> - Stop: stops logging data (default) - Run: logs data continuously - Period: logs data in the period of specified time
Overwrite on Full: Sets whether to overwrite old data by new ones when the memory for data storage is full. (Over the upper limit of 450,000.)
<ul style="list-style-type: none"> - No: discards the new data (default) - Yes: overwrites the old data by new ones
Sampling Interval: Sets the time interval for logging data. It is valid for both Run mode and Period mode. Tap the Sampling Interval to enter the sub-menu.
Default: 10 (unit: seconds)
Period Start: Sets the start time for Period mode
Default: date: 2014/06/01, time: 00: 00 : 00
Period End: Sets the stop time for Period mode
Default: date: 2014/06/02, time: 00: 00 : 00
Save: Saves the modification and returns to the Settings menu. All the changes take effect immediately after saving changes.
Skip: Returns to the Settings menu without saving any changes.

3.5 Ethernet

Tap the Ethernet item in the Settings menu to enter the sub-menu.

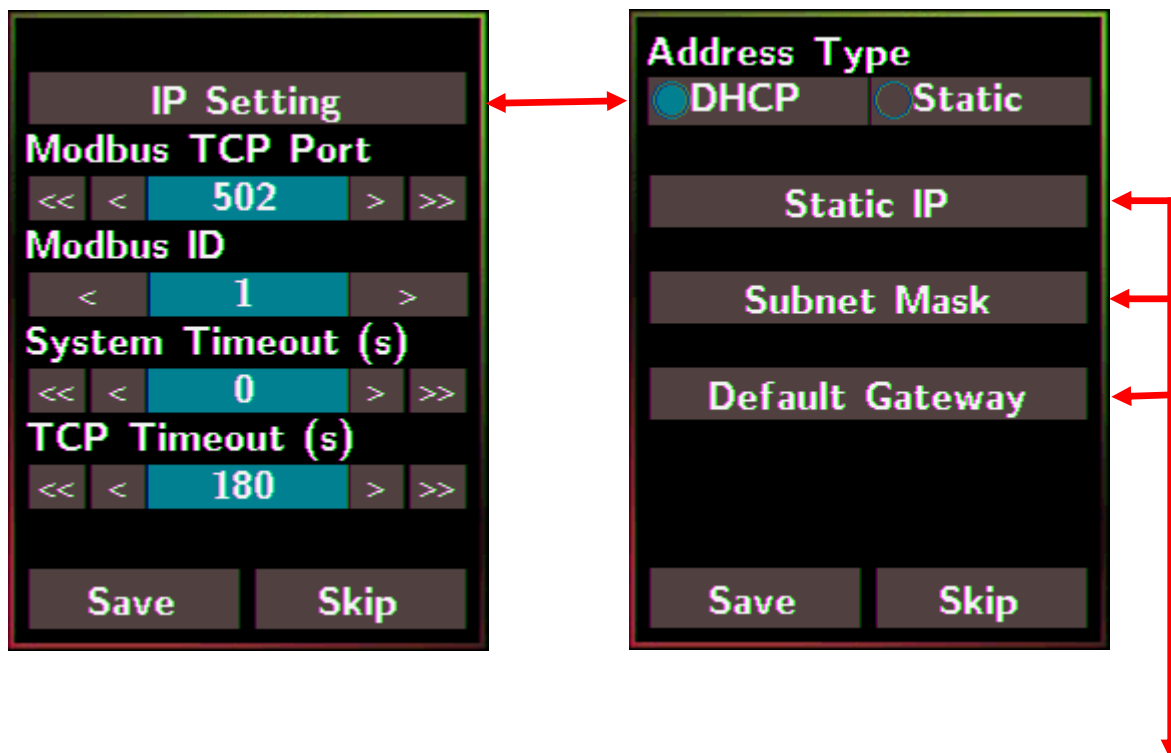

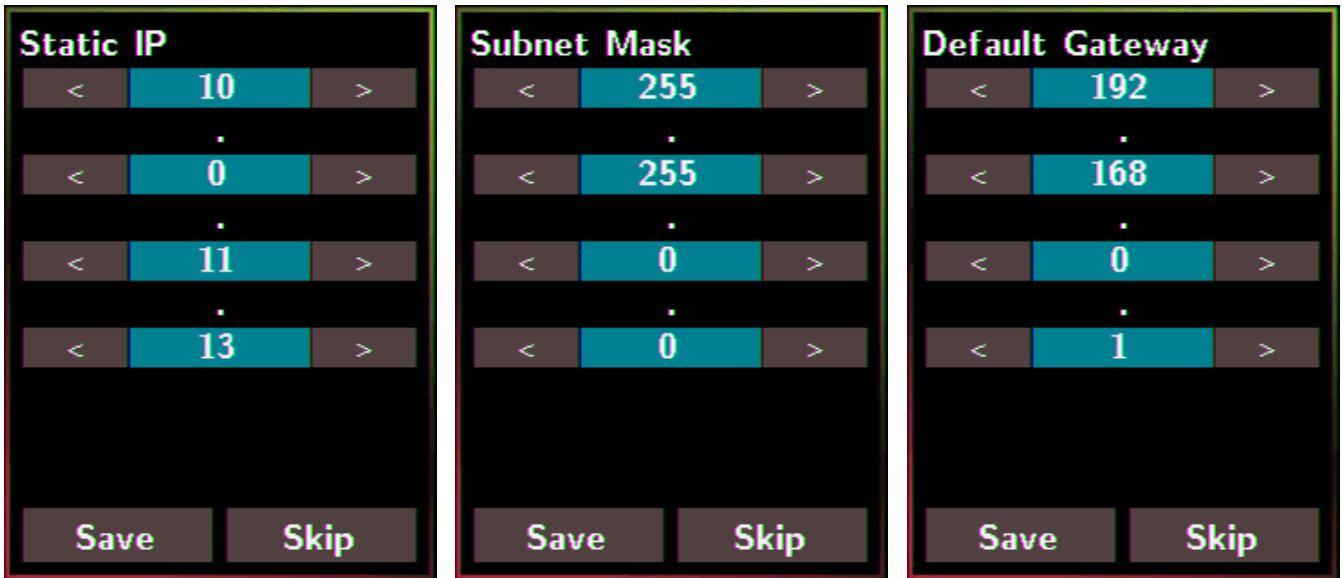

IP Setting: Taps the IP Setting item to enter the sub-menu.
Address Type: Static (default) Static IP: 192.168.255.1 (default) Subnet Mask: 255.255.0.0 (default) Default Gateway: 192.168.0.1 (default)
Modbus TCP Port: Sets the port number for Modbus TCP communication
Default: 502
Modbus ID: Sets the ID for Modbus TCP communication
Default: 1
System Timeout: Sets the timeout for rebooting a DL-300 which is abnormal or failure to communicate.
Default: 0 (unit: seconds)
TCP Timeout: Sets the timeout for TCP/IP communication. If there is no data received from Ethernet port over the time period of setting for TCP timeout, the established TCP/IP connections will be disconnected automatically.
Default: 180 (unit: seconds)
Save: Saves the modification and returns to the Settings menu. All the changes take effect immediately after saving changes.
Skip: Returns to the Settings menu without saving any changes.

3.6 RS-485

Tap the RS-485 item in the Settings menu to enter the sub-menu.

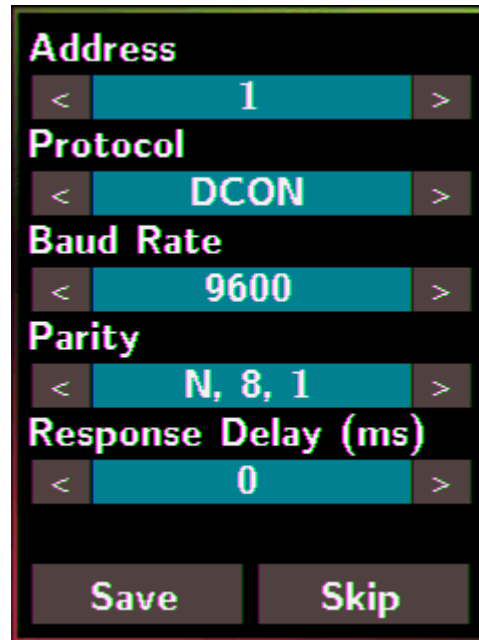

Address: Sets the address for a module.
Default: 1 Range: 0 ~ 255
Protocol: Sets the communication protocol.
- ModbusRTU (default) - DCON - DCONChkSum: uses DCON protocol and enables checksum validation feature
Baud Rate
Default: 9600 Support Baud Rate: 1200/ 2400/ 4800/ 9600/ 19200/ 38400/ 57600/ 115200 (unit: bps)
Parity
Default: N,8,1 Support format: N81, N82, E81, O81
Response Delay (ms): Sets the delay time between receiving the command and sending the data.
Default: 0 ms Range: 0 ~ 30 (unit: ms)
Save: Saves the modification and returns to the Settings menu. All the changes take effect immediately after saving changes.
Skip: Returns to the Settings menu without saving any changes.

4. Configuration via Web Browser

DL-300 logger has a built-in web server that provides simple web pages for remote monitoring real-time data and configuring the logger with a standard browser. For opening the web page in DL-300, the factory default IP address (192.168.255.1), Subnet Mask (255.255.0.0) and Gateway (192.168.0.1) need be set to available IP/Subnet Mask/Gateway addresses in your Ethernet environment. The Ethernet configuration can be set by entering the Settings menu from the touch screen or by web pages.

4.1 Search the DL-300 logger

eSearch is designed to search out the DL-300 logger connected on the same Ethernet network, it supports for Linux and Windows and is needless to install.

The eSearch can be downloaded from

CD:\Napdos\dl-300\utility\esearch\

<http://ftp.icpdas.com/pub/cd/usbcd/napdos/dl-300/utility/esearch/>

Before running eSearch, turn off firewall on computer, and connect the computer and DL-300 logger to Ethernet network.

1. Launch eSearch, click the **Search Servers** button to search the DL-300 modules connected to the network, the modules searched out will be listed as below.
2. Double click the module name searched in the list.

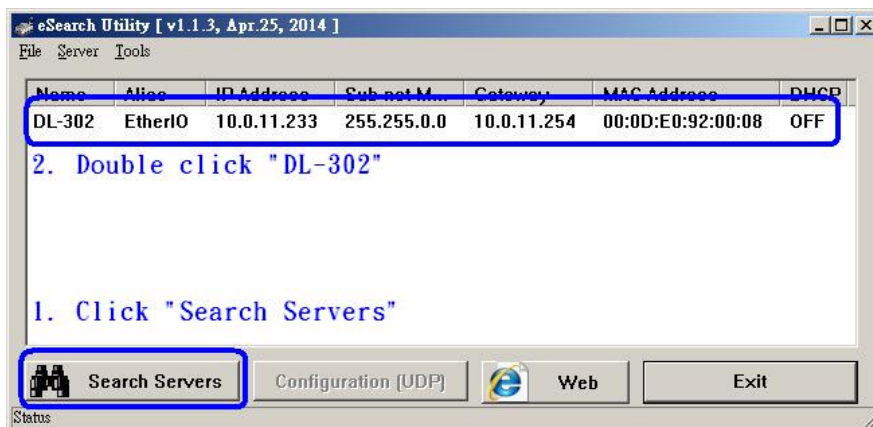

3. Set available IP Address, Sub-net Mask, Gateway (designated by your network administrator) and alias and click the **OK** button. The Alias for easy to identify each item will be shown at the bottom-left corner of the DL-300 screen.

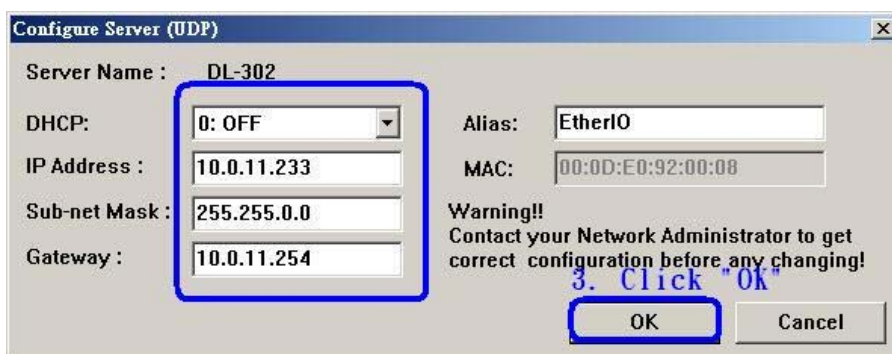

4.2 Logging into the DL-300

1. Enter the IP address for your DL-300 in the address bar of a web browser. (sec. 4.1). (The IP address could be obtained by going to the **Settings** >> **About** menu from the touch screen.)
2. Type the Login password, and click the **Submit** button. (The default Login password is **Admin**, case sensitive.)

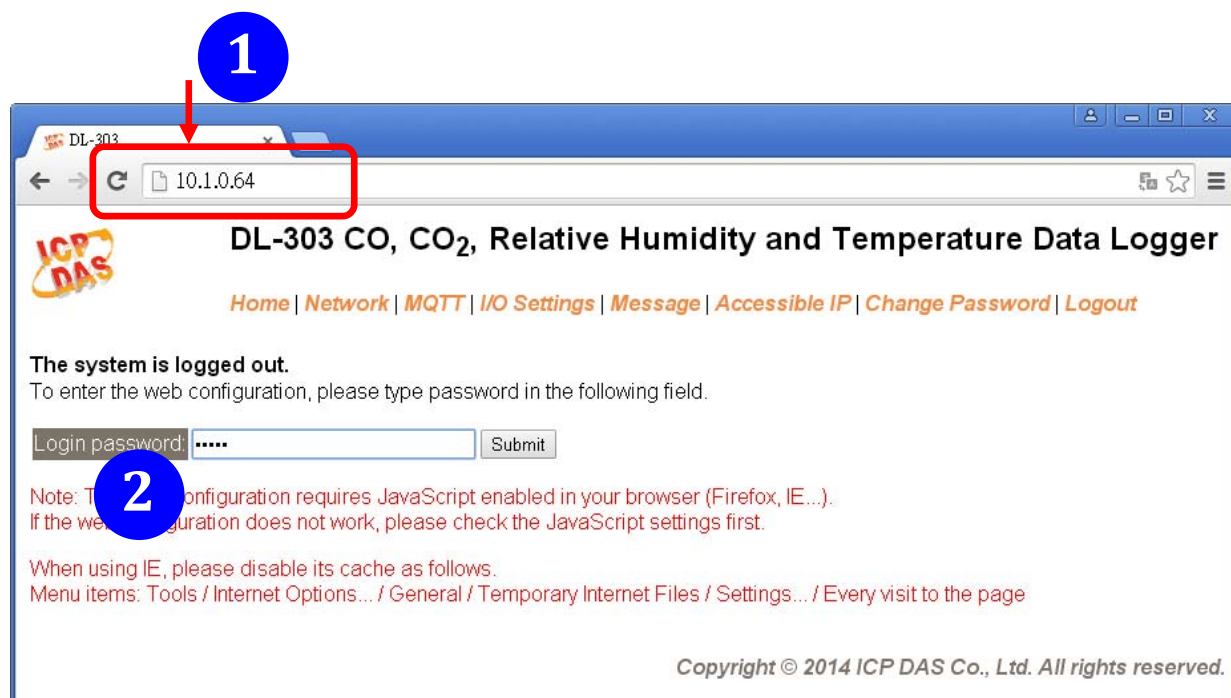

4.3 Home

The first page displayed is **Home**, it shows the based configuration of the DL-300 module and the real-time data as below:



DL-303 CO, CO₂, Relative Humidity and Temperature Data Logger

[Home](#) | [Network](#) | [MQTT](#) | [I/O Settings](#) | [Message](#) | [Accessible IP](#) | [Change Password](#) | [Logout](#)

Status & Configuration

Model Name	DL-303	Alias Name	Room303
Firmware Version	B2.6 [Jul. 16, 2015]	MAC Address	00-0D-E0-FF-FF-FF
IP Address	10.1.0.64	TCP Port Timeout (Socket Watchdog, Seconds)	180
Initial Switch	Off	System Timeout (Network Watchdog, Seconds)	0

Sensor Readings

Type	Value	Low Latched	High Latched
CO	0 ppm	0 ppm	1 ppm
CO ₂	756 ppm	483 ppm	1628 ppm
Relative Humidity	56.5%	53.6%	66.5%
Temperature	27.9 °C	26.5 °C	29.6 °C
Dew Point	18.5 °C	17.6 °C	21.3 °C

Clear Low Latched

Clear High Latched

In the **Sensor Readings** field is the real-time data of CO/CO₂ concentration, temperature, humidity and dew point, the minimum value (Low Latched) and maximum value (High Latched) logged. Clicking on the **Clear Low Latched** button and the **Clear High Latched** button can reset the latched data to current value and latch new minimum or maximum value.

Alarm

Type	Alarm Mode	Low Alarm Limit	High Alarm Limit	Low Alarm Status	High Alarm Status
CO	Disabled		50 ppm		Off
CO ₂	Disabled		1000 ppm		Off
Relative Humidity	Disabled	0.0%	100.0%	Off	Off
Temperature	Disabled	-50.0 °C	100.0 °C	Off	Off
Dew Point	Disabled	-50.0 °C	100.0 °C	Off	Off

Clear Latched Alarm

The Alarm table displays the settings of alarm mode, high alarm limit for CO/CO₂ concentration, temperature, humidity and dew point, low alarm limit for temperature, humidity and dew point, and the alarm status for each. Clicking on the **Clear Latched Alarm** button can clear the activated alarm status.

Digital Output

Channel	State	Action
DO0	Off	OFF <input checked="" type="radio"/> ON <input type="radio"/>

Set Digital Output

The **Digital Output** table shows the status of the relay output and the control button **Set Digital Output** to change the relay output status. The control function is invalid when any of the alarm modes is not disabled. If one of the alarm modes is enabled, the relay is linked to the alarm status for tapping audible/visual alarm.

At the end of the page are the data, time and device online time since powered on.

RTC

Date	2014-08-25	Time	09:20:51
------	------------	------	----------

Device Online Time

Device Online Time	0 Days, 00H:31M:13S
--------------------	---------------------

4.4 Network

The networks parameters are set on this page including DHCP enabled/disabled, IP/Subnet Mask/Gateway addresses, the port number and the NetID for Modbus TCP communication. Remember to click on the **Update Settings** button to update new parameters.

IP Address Configuration

Address Type	DHCP ▾		
Static IP Address	192	. 168	. 255 . 1
Subnet Mask	255	. 255	. 0 . 0
Default Gateway	192	. 168	. 0 . 1
MAC Address	00-0D-E0-92-00-19 (Format: FF-FF-FF-FF-FF-FF)		
	Modbus TCP Slave		
Local Modbus TCP port	502 (Default= 502)		
Local Modbus NetID	1 (Default= 1) Enable ▾ (Default= Enable)		
<input type="button" value="Update Settings"/>			

General Settings

System Timeout (Network Watchdog)	0 (30 ~ 65535 s, Default= 0, Disable= 0) Action:Reboot		
TCP Timeout	180 (5 ~ 65535 s, Default= 180, Disable= 0) Action:Cut-off		
Web Auto-logout	10 (1 ~ 65535 minutes, Default= 10, Disable= 0)		
Alias Name	EtherIO (Max. 18 chars)		
<input type="button" value="Update Settings"/>			

Item	Description	Default
System Timeout (Network Watchdog)	Sets the timeout for rebooting a DL-300 logger when it is abnormal or failure to communicate. Range: 30 ~ 65535 (unit: second) 0 = Disable	0 (Disable)
TCP Timeout	Sets the timeout for disconnecting a TCP connection when a DL-300 does not receive data coming from the Ethernet port. Range: 5 ~ 65535 (unit: second) 0 = Disable	180

Web Auto-logout	Sets the timeout for logout the web server in a logger when there is no any operation from the web browser interface. Range: 1 ~ 65535 (unit: minute) 0 = Disable	10
Alias Name	Sets an alias name for easy to identify a DL-300. The maximum length is 18 characters.	EtherIO

Restore Factory Defaults

Restore all options to their factory default states	Restore Defaults
Forced Reboot	Reboot

The **Reboot** button is used to reboot the DL-300. After pressing the button, a user needs to login the DL-300 logger again to using the web interface.

The **Restore Defaults** button can be used to restore the following settings to factory default values.

Item	Factory Default
IP address type	Static IP
Static IP	192.168.255.1
Default gateway	192.168.0.1
Subnet Mask	255.255.0.0
MAC address	Factory MAC address
Modbus TCP port	502
Modbus TCP NetID	1
Modbus TCP NetID	Enabled
System Timeout	0 (disabled)
TCP Timeout	180 seconds
Web auto logout	10 minutes
Alias name	EtherIO
Accessible IP	Disabled

4.5 MQTT

MQTT stands for MQ Telemetry Transport, it is a publish/subscribe, extremely simple and lightweight messaging protocol, designed for constrained devices and low-bandwidth, high-latency or unreliable networks.

The Publish-Subscribe messaging pattern requires a message broker. The broker is responsible for distributing messages to interested clients based on the topic of a message. Now the MQTT Version 3.1.1 becomes an OASIS standard, it is an ideal protocol for communicating with connected devices in the emerging "machine-to-machine" (M2M) and "Internet of Things" applications, and for mobile applications where bandwidth and battery power are at a premium.

Broker Settings

IP Address	<input type="text" value="192"/> . <input type="text" value="168"/> . <input type="text" value="255"/> . <input type="text" value="10"/>
Port	<input type="text" value="1883"/> (Default= 1883)
<input type="button" value="Update Settings"/>	

Input the IP address and port number for the MQTT broker and click on the **Update Settings** button to save the parameters.

Publish Settings

Cycle	<input type="text" value="1000"/> (400 ~ 65500 ms, in 10 ms step, Default= 1000)
Module Topic Name	<input type="text" value="EtherIO/"/> (Max. 255 chars)
CO2 Sub Topic Name	<input type="text" value="CO2"/> (Max. 63 chars) <input type="button" value="Enable"/> ▼
Relative Humidity Sub Topic Name	<input type="text" value="RH"/> (Max. 63 chars) <input type="button" value="Enable"/> ▼
Temperature (°C) Sub Topic Name	<input type="text" value="TC"/> (Max. 63 chars) <input type="button" value="Enable"/> ▼
Temperature (°F) Sub Topic Name	<input type="text" value="TF"/> (Max. 63 chars) <input type="button" value="Enable"/> ▼
Dew Point (°C) Sub Topic Name	<input type="text" value="DC"/> (Max. 63 chars) <input type="button" value="Enable"/> ▼
Dew Point (°F) Sub Topic Name	<input type="text" value="DF"/> (Max. 63 chars) <input type="button" value="Enable"/> ▼
<input type="button" value="Update Settings"/>	

- Cycle: sets the time period for update the publish messages in millisecond.
- Module Topic Name: sets the module topic name.
- CO/CO2/ Relative Humidity/ Temperature (°C)/ Temperature (°F)/ Dew Point (°C)/ Dew Point (°F) Sub Topic Name: sets the sub topic name for each item.

A MQTT client subscribes the messages form a MQTT broker by specifying the topic name as

Module Topic Name + Sub Topic Name

For example, to subscribe the CO₂ level in this case, a MQTT client subscribes the topic name from a MQTT broker as

EtherIO/CO2

Subscribe Settings

Message Attribute Sub Topic Name	Attr (Max. 63 chars)
Message Sub Topic Name	Msg (Max. 63 chars)
<input type="button" value="Update Settings"/>	

Input the Message Attribute Sub Topic Name and Message Sub Topic Name, and then click on the **Update Settings** button to save the parameters. Users can remotely display message or set the message attribute by publishing MQTT messages to the topic name of [Module Topic Name + Message Sub Topic Name] or [Module Topic Name + Message Attribute Sub Topic Name]

- Message Attribute Sub Topic Name: sets the sub topic name for message attribute. If a MQTT message is published to topic name: "Module Topic Name + Message Attribute Sub Topic Name" for a DL-300 logger, the logger will follow the MQTT message described to set the attribute for displaying a message on the screen.

Note: the message attribute needs be passed before the message published to take the settings effect.

The Attribute message contains 16 hexadecimal numbers separated with comma characters. The following table lists the description of the attribute message.

Data Number	Description
1	Sets if the buzzer sounds when displaying message. 0: No, 1: Yes.
2	Sets if the acknowledge button shows for manually closing message. 0: No, 1: Yes.
3	Sets the time for displaying message, ranged from 0 to FFFF, in seconds. 0: displaying message without time limit.
4	Sets the background color in RGB triplet, a hexadecimal number ranged from 0 to FFFFFFFF in the following order: Red value (0 ~FF)/Green value (0 ~FF)/Blue value (0 ~FF). For example, 0 is black, FF0000 is bright red, FF00 is bright green, FF is bright blue, and FFFFFFFF is white.
5	Sets the text alignment for the first line. 0: left-aligned, 1: centered, 2: right-aligned.
6	Sets the text color for the first line, ranged from 0 to FFFFFFFF in RGB triplet.
7	Sets the text alignment for the second line. 0: left-aligned, 1: centered, 2: right-aligned.
8	Sets the text color for the second line, ranged from 0 to FFFFFFFF in RGB triplet.
9	Sets the text alignment for the third line. 0: left-aligned, 1: centered, 2: right-aligned.
10	Sets the text color for the third line, ranged from 0 to FFFFFFFF in RGB triplet.
11	Sets the text alignment for the fourth line. 0: left-aligned, 1: centered, 2: right-aligned.
12	Sets the text color for the fourth line ranged from 0 to FFFFFFFF in RGB triplet
13	Sets the text alignment for the fifth line. 0: left-aligned, 1: centered, 2: right-aligned.
14	Sets the text color for the fifth line, ranged from 0 to FFFFFFFF in RGB triplet
15	Sets the text alignment for the sixth line. 0: left-aligned, 1: centered, 2: right-aligned.
16	Sets the text color for the sixth line, ranged from 0 to FFFFFFFF in RGB triplet

For example, to set the attribute for displaying message by publishing a MQTT message:

1. Topic name: **EtherIO/Attr**
(Module Topic Name + Message Attribute Sub Topic Name)
2. Message content: 0, 0, 0, 8394, 0, FFFFFFFF, 0, FFFFFFFF, 0, FFFFFFFF, 0, FFFFFFFF, 0, FFFFFFFF, 0, FFFFFFFF

It sets the attributes for displaying message with no beep sound, no acknowledge button, no time limit, background  , all the lines are left-aligned and white text color.

Note: the message attribute needs be passed before the message published to take the settings effect.

- Message Sub Topic Name: sets the sub topic name for the message displayed on the screen. When a MQTT message published to “Module Topic Name + Message Sub Topic Name” for a DL-300 logger, the logger will displayed the message.

Note: A message can have a maximum of 6 lines and 14 half-width characters or 7 full-width characters maximum each line. “\r” (0Dh) is used to do a new line.

The example for publishing a MQTT message to display on the DL-300:

1. Topic name: **EtherIO/Msg** (Module Topic Name + Message Sub Topic Name)
2. Message content: Turn on the ventilation fan.

4.6 I/O Settings

Temperature

Scale	°C ▼
<input type="button" value="Update Settings"/>	

Users can change the temperature unit to Fahrenheit or Celsius in this field.

CO₂ Automatic Baseline Correction

Mode	Disabled ▼
<input type="button" value="Update Settings"/>	

To Enable/Disable the CO₂ Automatic Baseline Correction function. It is supported on the DL-302 and DL-303 only.

Q & A

Q: What is ABC (Automatic Baseline Correction)?

A: ABC stands for the Automatic Baseline Correction which is used to adjust a shifted baseline to the carbon dioxide level in fresh air. In case of normal indoor application, the carbon dioxide level drops to nearly outside air where there are no human, green plants or anything to elevate the carbon dioxide levels on weekday evenings or weekends, the ABC algorithm constantly keeps track of the lowest reading and slowly corrects it as the expected value in fresh air typically around 400 ppm.

Q: Why I need to enable the ABC?

A: When the CO₂ concentration detected in a period time of unoccupied space is greater than the base value of 400ppm, enable the ABC function to adjust the baseline. Be careful that the ABC will not work if a space is constantly occupied such as a hospital, 24-hr factory, 24-hr store, green house or other applications where CO₂ levels may be elevated at all times.

Alarm Configuration

Type	Alarm Mode	Low Alarm Limit	High Alarm Limit
CO	Disabled ▼		50
CO ₂	Disabled ▼		1000
Relative Humidity	Disabled ▼	0.0	100.0
Temperature	Disabled ▼	-50.0	100.0
Dew Point	Disabled ▼	-50.0	100.0
Beep On CO And CO ₂ Alarm Time	30 (0: beep off, 1 to 250: beep on alarm time in seconds, 251: beep on alarm continuously)		
<input type="button" value="Update Settings"/>			

All the settings take effect after clicking the *Update Settings* button.

Item	Description	Default
Alarm Mode	<p>- Disabled: Disables alarm function.</p> <p>- Momentary: If a measurement value higher than the High Alarm Limit or lower than the Low Alarm Limit, the alarm occurs until the measurement value is within a range from Low Alarm Limit to High Alarm Limit. (For CO/CO₂ level, until the measurement value is lower than the High Alarm Limit.) The Alarm LED turns red, and the relay turns to on for every alarm event, and a sound alarm beeps as the setting in <i>Beep on Alarm Time</i> for CO/CO₂ high limit alarm events during the alarm stage.</p> <p>- Latched: If a measurement value higher than the High Alarm Limit or lower than the Low Alarm Limit, the alarm occurs. The Alarm LED turns red, the relay turns to on for every alarm event, and a sound alarm beeps as the setting in <i>Beep on Alarm Time</i> for CO/CO₂ high limit alarm events. Even though the alarm event is not presented, the alarm status is latched; the Alarm LED keeps red, and the relay keeps on and the sound alarm keeps beeping if it is set to beeping continuously.</p>	Disabled

Low Alarm Limit	Sets the Low alarm limit conditions for Relative Humidity/ Temperature/ Dew Point.	
High Alarm Limit	Sets the High alarm limit conditions for CO/CO ₂ /Relative Humidity/ Temperature/ Dew Point.	
Beep On CO And CO ₂ Alarm Time	Sets the time for beeping alarm. It is valid when the high limit alarm for CO/CO ₂ occurs. Range: 1 ~ 250 (unit: second) 0 = disable the beeping alarm 251 = continue the beeping alarm without stop	251

Digital Output

Channel	Power On Value	Safe Value
DO0	Off ▼	Off ▼
Host Watchdog Timeout (seconds)	0 (5 to 65535 Seconds, Default= 0, Disable= 0)	
Update Settings		

Set the *Power On Value* and *Safe Value* for the relay output, and the *Host Watchdog Timeout* timer for RS-485 communication; if a host does not send a command over the setting time, the Host Watchdog timeout occurs and the relay outputs the status set for Safe value. The settings for Power On Value and Safe Value are unavailable when any one setting in the *Alarm Mode* is enabled.

RTC

Year	2015 (2000 to 2159)
Month	8 (1 to 12)
Date	6 (1 to 31)
Hour	17 (0 to 23)
Minute	29 (0 to 59)
Second	7 (0 to 59)
Update Settings	

All the settings take effect after clicking the *Update Settings* button.

Data Logger

Status	Running
Change Logging	Run ▼
Overwrite on Full	No ▼
Sampling Interval - Hour	0 (0 to 24)
Sampling Interval - Minute	6 (0 to 59)
Sampling Interval - Second	0 (0 to 59)
Period Start - Year	2014 (2000 to 2159)
Period Start - Month	6 (1 to 12)
Period Start - Date	1 (1 to 31)
Period Start - Hour	0 (0 to 23)
Period Start - Minute	0 (0 to 59)
Period Start - Second	0 (0 to 59)
Period End - Year	2014 (2000 to 2159)
Period End - Month	6 (1 to 12)
Period End - Date	2 (1 to 31)
Period End - Hour	0 (0 to 23)
Period End - Minute	0 (0 to 59)
Period End - Second	0 (0 to 59)
<input type="button" value="Update Settings"/>	

In this table it shows the settings for data logger.

All the settings take effect after clicking the *Update Settings* button.

Item	Description	Default
Status	<ul style="list-style-type: none"> - Running: the data logger is running - Stopped: the data logger is stopped 	
Change Logging	Sets the mode for data logger <ul style="list-style-type: none"> - Stop: stops the data logger - Run: continues logging data - Period: logs data in the specified period time 	Stop
Overwrite on Full	Sets whether to overwrite old data by new ones when the memory for data storage is full. (Over the upper limit of	No

	450,000.) - No: discards the new data (default) - Yes: overwrites the old data by new ones	
Sampling Interval	Sets the time interval for logging data. It is valid for both Run mode and Period mode. - Sampling Interval – Hour: sets the hour for log interval - Sampling Interval – Minute: set the minute for log interval - Sampling Interval – Second: sets the second for log interval	10 (s)
Period Start	Sets the start time for Period mode.	
Period End	Sets the stop time for Period mode	

Reset data logger to empty

Reset Data Logger

Click the *Reset Data Logger* button to clear the data in data storage memory.

LCD

Back Light Setting	180	(0 to 255)
Screen Saver Time	200	(0 to 65535 Seconds, Default= 30, Disable= 0)
Update Settings		

Set the LCD back light and screen saver time and click on the *Update Settings* button to take the settings effect.

Back Light Setting is ranged from 0 to 255 to control the back light from the darkest black to brightest, default is 180.

Screen Saver Time specifies the user idle time before the screen saver is launched. If set to zero, the screen saver will not launch. Default is 30 seconds.

4.7 Message

Message Settings

The color is expressed by a six-digit hexadecimal value, where FF0000 denotes red, 00FF00 denotes green and 0000FF denotes blue. The default background color is 008394 and the default foreground color is FFFFFFFF.

Beep	Off ▼
Acknowledge Button	No ▼
Display Time	0 (1 to 65535 Seconds, Default= 0, Continuous= 0)
Background Color	008394
Line1	Color: FFFFFFFF Justify: Center ▼
Line2	Color: FFFFFFFF Justify: Center ▼
Line3	Color: FFFFFFFF Justify: Center ▼
Line4	Color: FFFFFFFF Justify: Center ▼
Line5	Color: FFFFFFFF Justify: Center ▼
Line6	Color: FFFFFFFF Justify: Center ▼
Update Settings	

Note: The settings should be updated before showing the messages.

In the Message Settings table, users can set the message properties such as beeping or not, displaying acknowledge button or not, time for message displayed, background color, line color and align.

The properties need be updated before showing the messages.



← Acknowledge Button to close message manually.

Messages

The maximum number of a line is 14 halfwidth characters or 7 fullwidth characters.

Showing Message	No
Line1	<input type="text"/>
Line2	<input type="text"/>
Line3	<input type="text"/>
Line4	<input type="text"/>
Line5	<input type="text"/>
Line6	<input type="text"/>
<input type="button" value="Show Messages"/>	

After updating the Message Settings, input the message content in the Message table. A message is limited to six lines maximum and 14 half-width characters or 7 full-width characters maximum each line.

4.8 Accessible IP

For limiting the devices to access the DL-300 logger, users can specify particular devices by setting their IP addresses on this page. When the addresses are 0.0.0.0 from IP1 to IP5, all the devices can access the logger. Once any of the 5 IP address columns is set, only the device with which IP is saved in the list can access the logger.

➤ Set accessible IP

1. Select the radio button for *Add* ____ . ____ . ____ . ____ *To The List* and type the IP address for the accessible device in the following text box.
2. Click on the *Submit* button to the setting effect without restarting.

If the IP setting needs to be saved for use after repowering, check the checkbox for *Save to Flash* before clicking the *Submit* button.

Accessible IP Settings

Accessible IP List	IP Address
IP1	0.0.0.0
IP2	0.0.0.0
IP3	0.0.0.0
IP4	0.0.0.0
IP5	0.0.0.0

Add [] . [] . [] . [] To The List
 Delete IP# []
 Delete ALL
 Save to Flash

Copyright © 2014 ICP DAS Co., Ltd. All rights reserved.
10.1.0.31/filter.html

➤ Delete IP setting

Select the radio button for *Delete IP#* to delete a specified IP or the radio button for *Delete All* to delete all the IP, check the checkbox for *Save to Flash* and then click the *Submit* button to take the delete operation effect.

4.9 Change Password

On this page users can change the passwords for login the logger and locking the touch screen. The factory default for the DL-300 touch screen has no password protection. After setting the password for touch screen, each time whoever wants to change to settings from the touch screed, the password will be requested.

➤ Change Web Password

The password for logging into the web page is **Admin** and can be changed in the *Change Web Password* field. The password can be alphabetic characters or numbers and up to 12 characters (case sensitive).

To change the password, uses need enter the *Current password*, *New password*, and *Confirm new password* columns and click the Submit button for Change Web Password to take the setting effect.



DL-302 CO₂, Relative Humidity and Temperature Data Logger

[Home](#) | [Network](#) | [I/O Settings](#) | [Accessible IP](#) | [Change Password](#) | [Logout](#)

Change Web Password

The length of the web password is 12 characters maximum.

Current password	<input type="text"/>
New password	<input type="text"/>
Confirm new password	<input type="text"/>
	<input type="submit" value="Submit"/>

Change Touch Password

The length of the touch password is 8 digits maximum.

New password	<input type="text"/>
Confirm new password	<input type="text"/>
	<input type="submit" value="Submit"/>

➤ Change Touch Password

It is recommended to set the Touch Password to protect the logger from unexpected operation. Once the password is set, the password will be requested when entering the setting menu from the touch screen.

The Touch password is numbers from 0 to 9 and up to 8 digits. Enter your password in *New password* and *Confirm new password* and then click the Submit button for changing touch password to take the setting effect. If the password contains non-number characters, the Parameter Error will be displayed as below.



DL-302 CO₂, Relative Humidity and Temperature Data Logger

[Home](#) | [Network](#) | [I/O Settings](#) | [Accessible IP](#) | [Change Password](#) | [Logout](#)

Parameter Error

One of the parameters entered on the previous page was either invalid or missing. Please use the back button on your browser to return to the configuration page and check the values entered, then reapply your setting changes.

➤ Cancel Touch Password

Empty the text columns for New password and Confirm new password and then clicking the Submit button for changing touch password.



DL-302 CO₂, Relative Humidity and Temperature Data Logger

[Home](#) | [Network](#) | [I/O Settings](#) | [Accessible IP](#) | [Change Password](#) | [Logout](#)

Change Web Password

The length of the web password is 12 characters maximum.

Current password	<input type="text"/>
New password	<input type="text"/>
Confirm new password	<input type="text"/>
	<input type="button" value="Submit"/>

Change Touch Password

The length of the touch password is 8 digits maximum.

New password	<input type="text"/>
Confirm new password	<input type="text"/>
	<input type="button" value="Submit"/>

4.10 Logout

Click the Logout on any page to logout the DL-300.



DL-302 CO₂, Relative Humidity and Temperature Data Logger

[Home](#) | [Network](#) | [I/O Settings](#) | [Accessible IP](#) | [Change Password](#) | [Logout](#)

The system is logged out.

To enter the web configuration, please type password in the following field.

Login password:



Note: This web configuration requires JavaScript enabled in your browser (Firefox, IE...).
If the web configuration does not work, please check the JavaScript settings first.

When using IE, please disable its cache as follows.

Menu items: Tools / Internet Options... / General / Temporary Internet Files / Settings... / Every visit to the page

5. Configuration via RS-485

- The factory default settings for RS-485 communication
 - Address: 1
 - Protocol: Modbus/RTU
 - Baudrate: 9600
 - Parity: N,8,1
 - Response Delay (ms): 0

Note

If there are multiple DL-300 loggers connected to the same RS-485 network, each logger needs be set with a unique RS-485 address. More than one module having the same address will cause communication failure

- Testing RS-485 Communication
 1. Download the DCON Utility Pro from
CD:\Napdos\DL-300\utility\DCON_utility_pro or
http://ftp.icpdas.com/pub/cd/usbcd/napdos/dl-300/utility/dcon_utility_pro

2. Launch the DCON_Utility_Pro.exe.

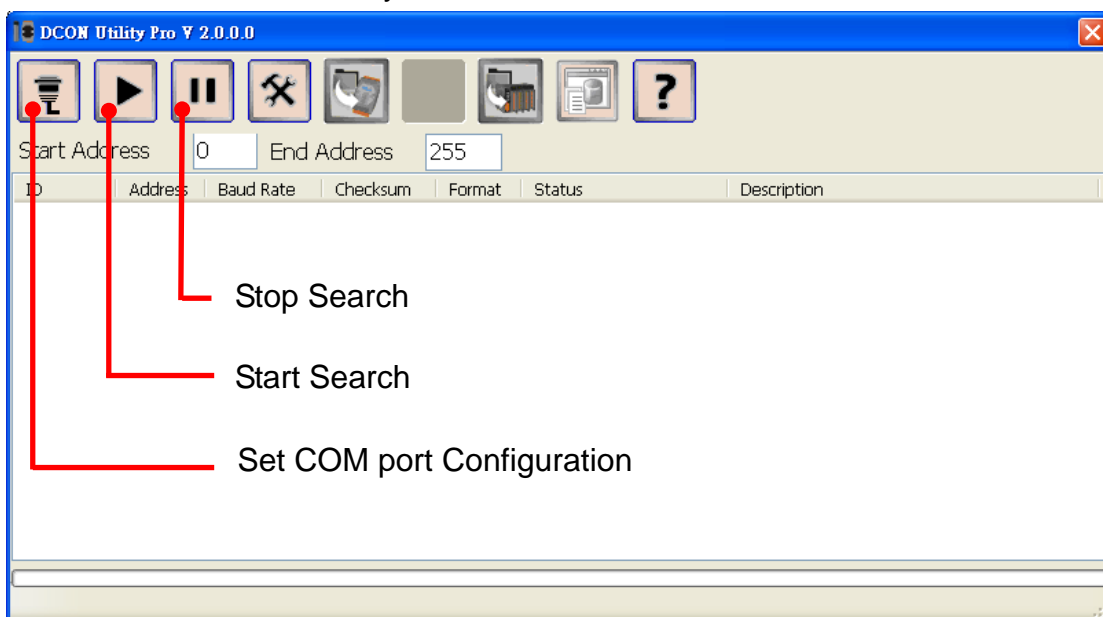

3. Click the icon  to configure the COM port.

4. Select the COM Port number used to connect the DL-300 logger.

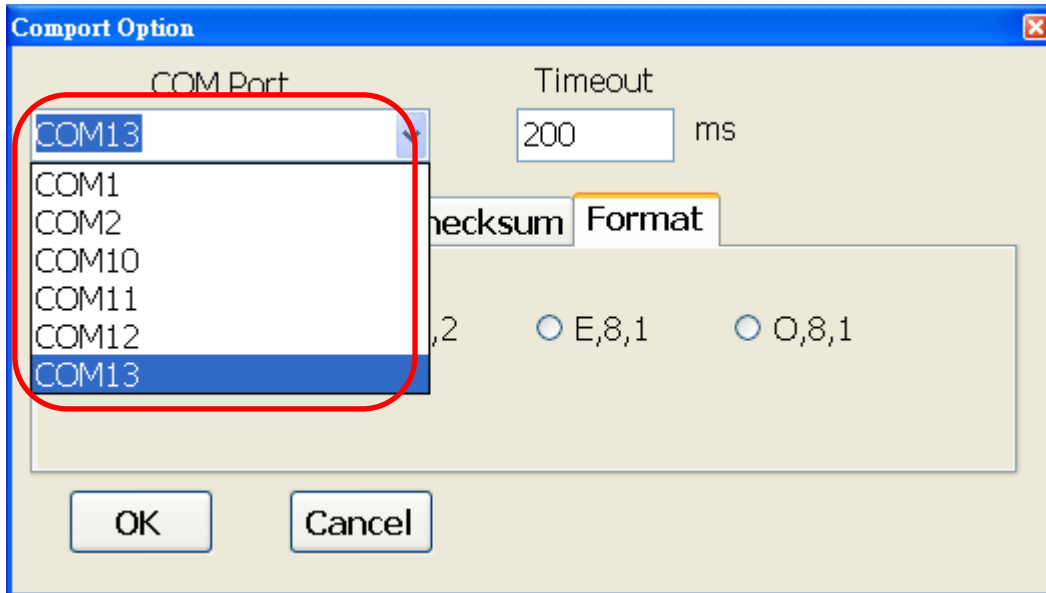

5. The Baud Rate is factory default to 9600 bps, make sure the baud rate setting in the logger is checked in the Comport Option dialog box.

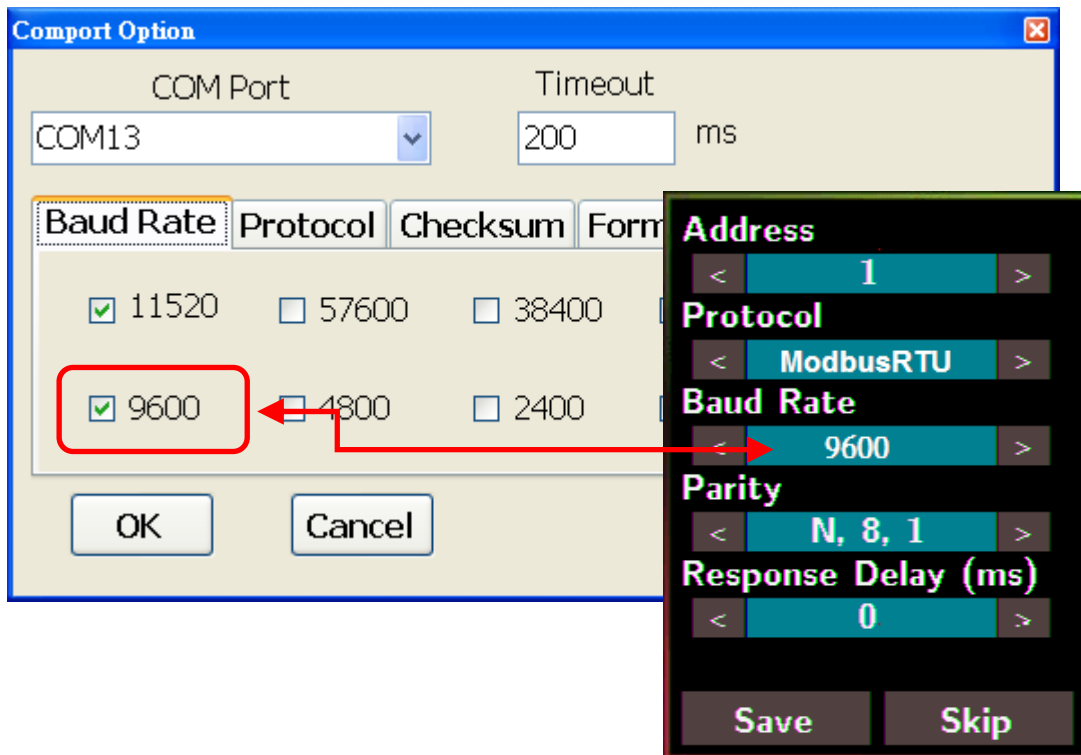

6. Select the Protocol tab and check the protocol that set in the logger.

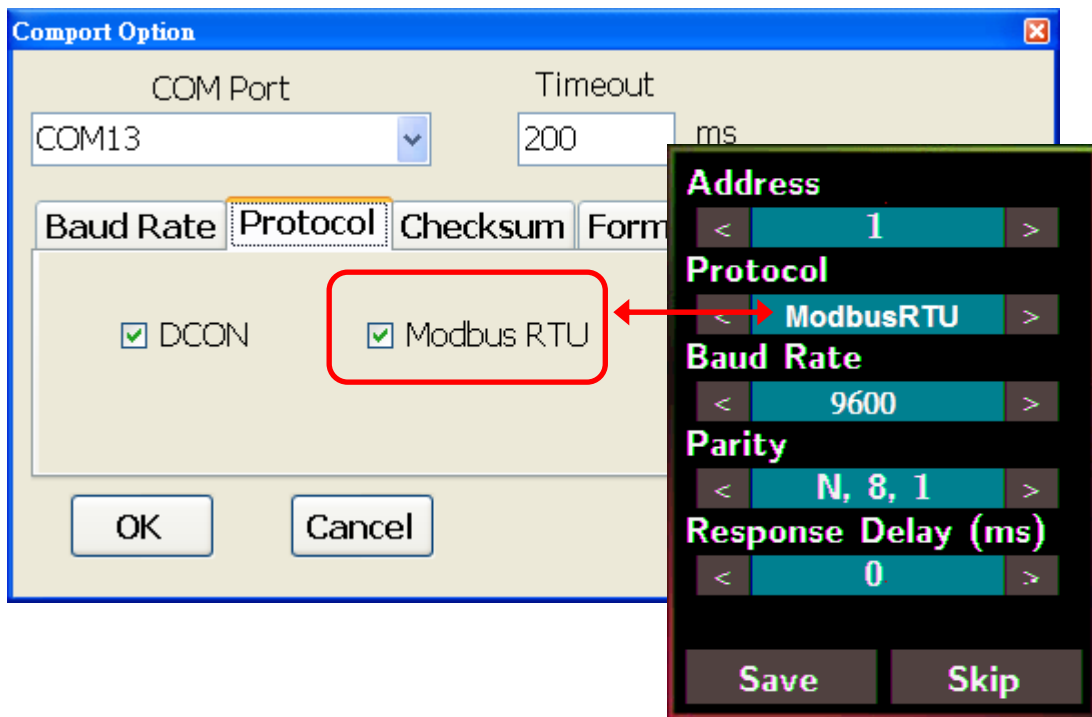

7. Select the Format tab and check the parity that set in the logger.

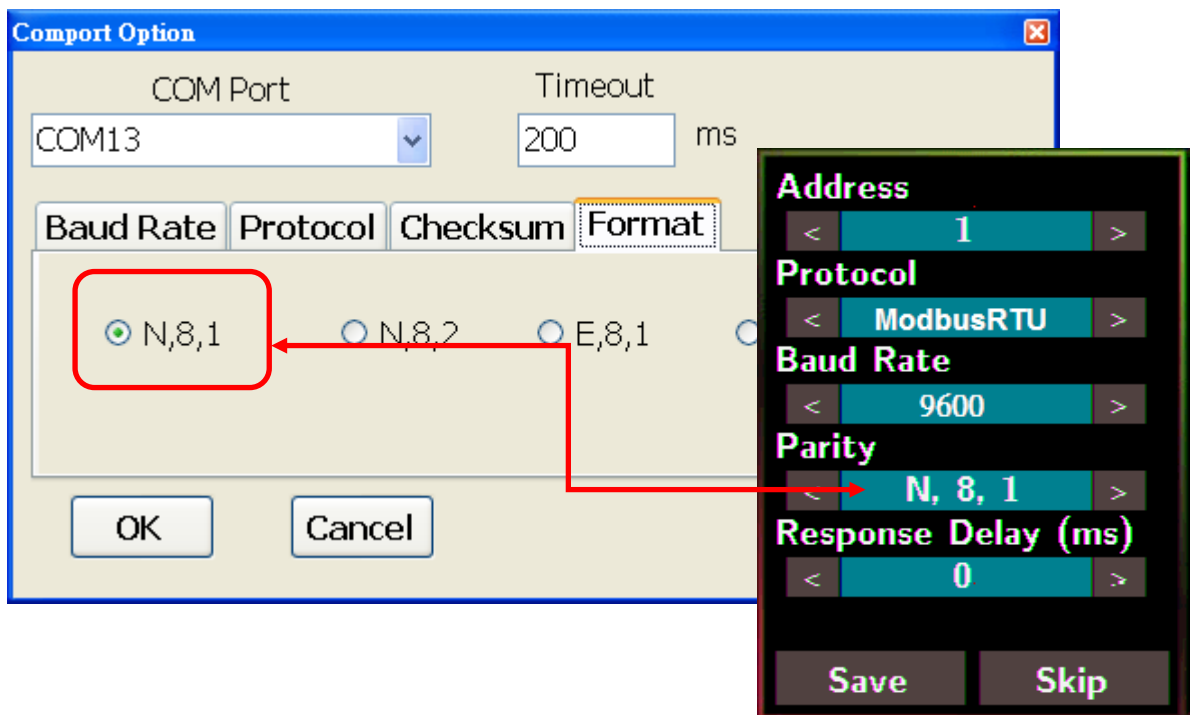

8. Click the Start Search icon.



9. The DL-300 logger searched out will be listed as below.

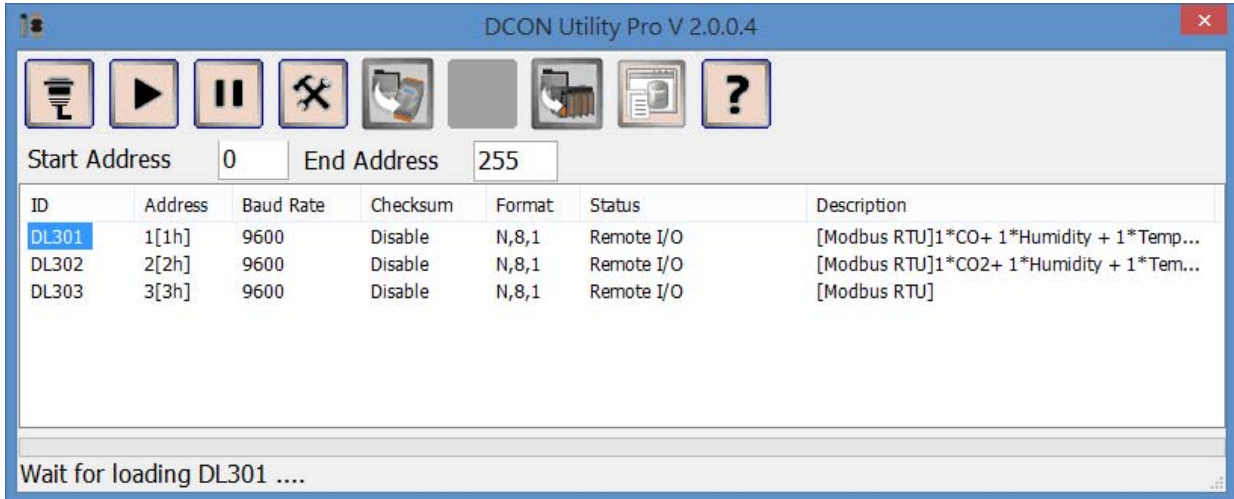

10. Click the module name to configure the logger.

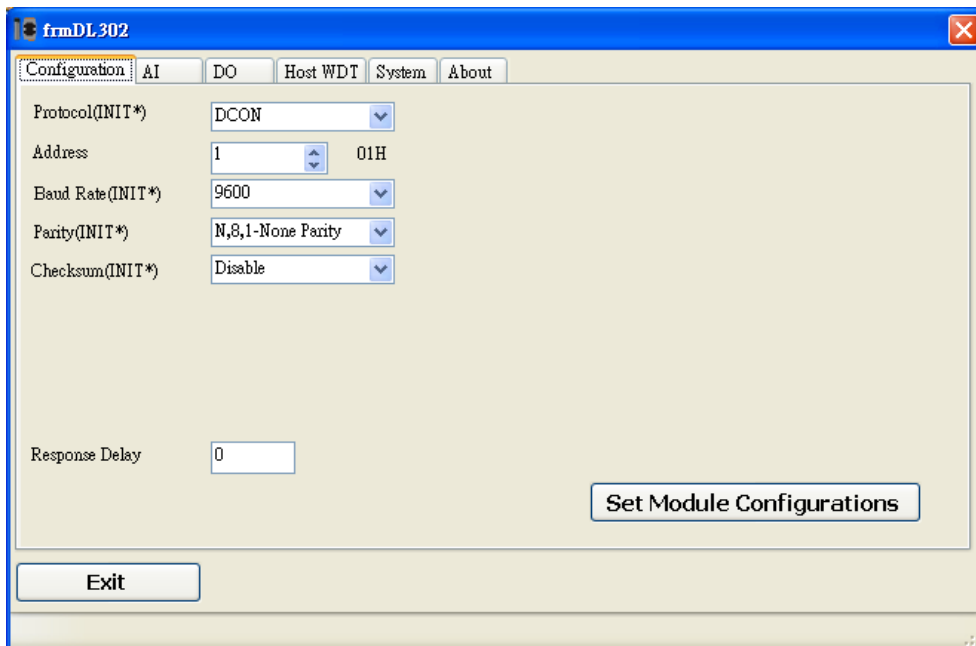

Note

The Protocol/Baud Rate/Parity/Checksum items marked with "(INIT*)" means that when any of those items needs be modified, the pin 4.INIT needs to be set in ON position and power cycle the logger, then the item can be modified. After complete setting, set the pin 4.INIT back to OFF position and power cycle the logger again to take the setting effect.

➤ AI tab

CO/CO₂ level

Alarm Status

Humidity

Adjust the humidity offset

Set alarm mode/
High alarm limit/
beep alarm time

Temperature and
Dew point temperature

Adjust the temperature
offset (°C)

➤ **DO tab**

On this DO tab, users can control the relay to output ON or OFF status, and set the power on value and safe value for the relay output.

When any one of the high/low limit alarm for CO/CO₂ concentration, temperature, humidity and dew point is enabled, the functions on this tab are all disabled as below.

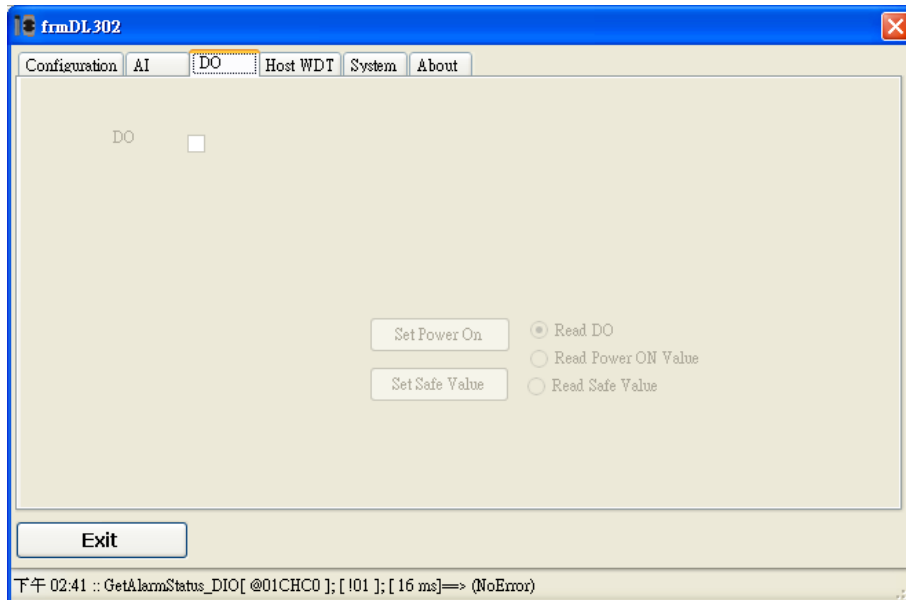

If all the alarm events are disabled, the functions are available as below:

The checkbox can be used to control and display the DO status. Check/Uncheck the checkbox can control the relay output. Checked/Unchecked symbol also means the DO status

When the buttons are clicked, the DO status will be set as the Power On value or Safe value.

Select one of the radio button and the checkbox next to DO will display the setting for selected item.

➤ Host Watchdog

Host Watchdog is used to monitor the RS-485 communication status; if the host (PC) does not send command “~**” in the time period of WDT Timeout setting, the enabled Host Watchdog will announce the timeout error and turn the relay output to Safe value to avoid an unsafe act. Users can not control the relay until the command “~AA1” is sent to clear the WDT timeout status.

On this tab:

1. Set the time period for WDT timeout, check the checkbox next to Enable WDT and click the Set WDT button to enable the Host watchdog.
2. Check the checkbox next to Send Host OK to send the “~**” command.
3. Uncheck the checkbox next to Send Host OK to stop sending ~** command, the Host watchdog timeout will occur and relay will turn to Safe value.
4. Click the Reset WDT button to clear the Host watchdog timeout status.
5. Uncheck the checkbox next to Enable WDT and click the Set WDT button to disable the Host watchdog.

Note

The relay will not turn to Safe value when any one of the alarm for CO/CO₂ concentration, temperature, humidity and dew point is enabled. If any one alarm is enabled, the relay will be linked to the Alarm status. In case an Alarm occurs, the relay turns ON, it can be used to turn on the user’s alarm light or beeping alarm or other device.

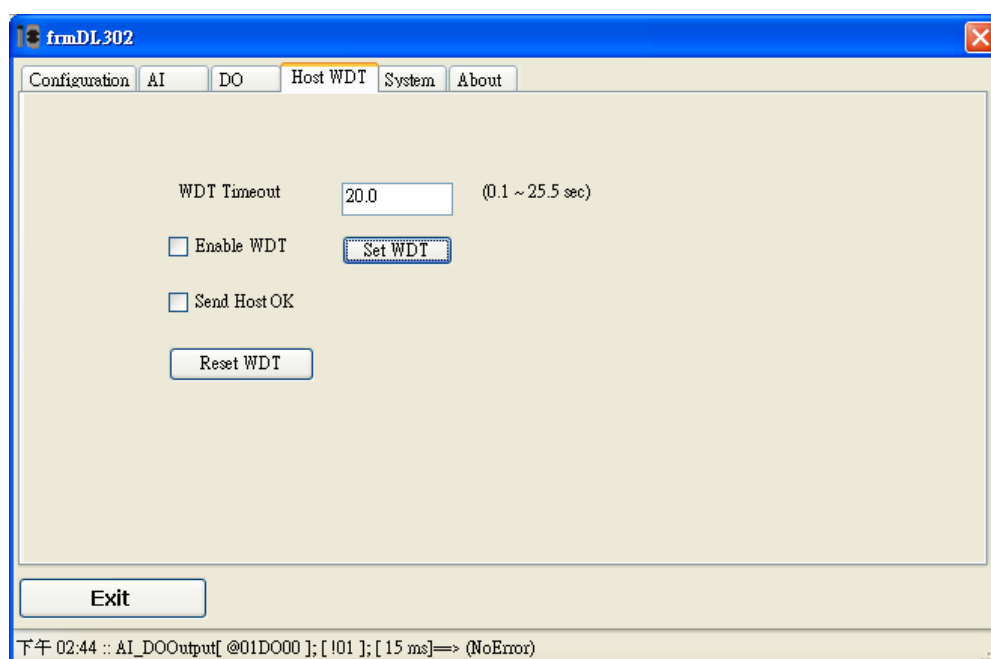

➤ System Tab

Click the Edit button to enable settings on this tab.

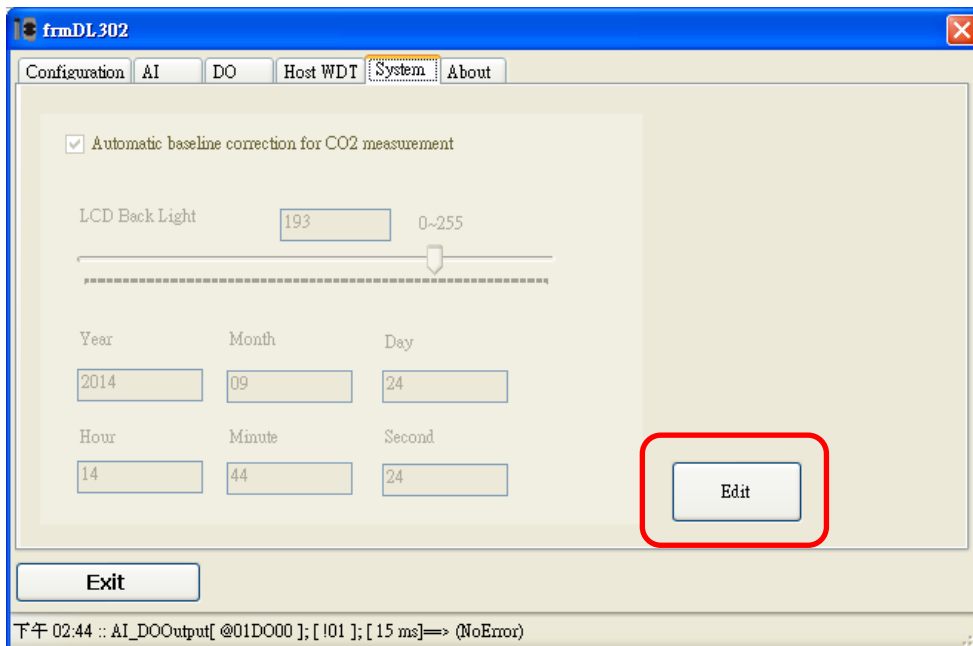

Check/Uncheck the item to
Enable/Disable ABC function
(For DL-302 and DL-303 only)

Set the LCD Back Light

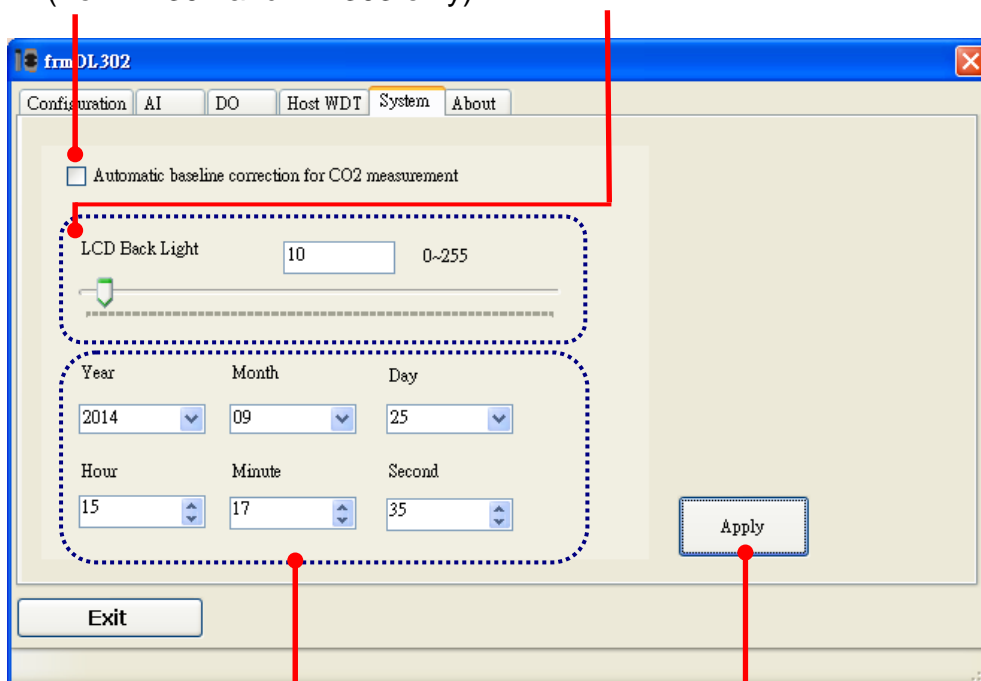

Set Date and Time

Click the Apply button to
save settings.

➤ INIT

In case of the following situations, users have to set the pin 4.INIT on SW1 in the ON position and power-cycle the DL-300 module:



- Change protocol from PC
- Change DCON configuration such as baudrate, parity and checksum
- Communication failure with a DL-300 module.

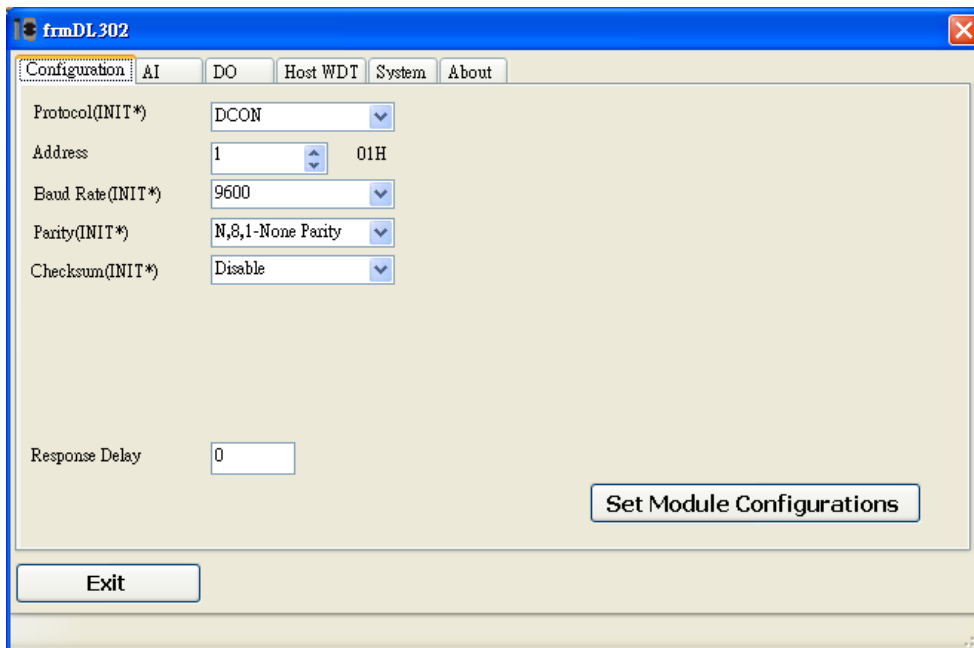

When a DL-300 module is powered-on with the pin 4.INIT in ON position, the protocol is DCON, address is 0, Baud Rate is 9600 bps, Parity is set to N/8/1 and Checksum is disabled.

After configuring the communication parameters, click the *Set Module Configurations* button, set the INIT to OFF position and power-cycle the DL-300 to take the settings effect.



Note

The INIT switch does not need to be set in the ON position when changing the address, baudrate and parity for ModbusRTU communication; users only have to power-cycle the module after complete configuration.

6. Monitoring via Mobile Devices

The iAir App can be used to monitor real-time data of CO/CO₂ level, temperature and humidity anywhere and anytime without any complicated configuration. The DL-300 modules and your mobile devices such as smart phones or tablets need be addressed on the same network, and then you can get the real-time data from DL-300 loggers by entering a specific IP address, or by performing an automatic search for available devices.

If a DL-300 can not be searched in the iAir App, please contact with the network administrator to make sure the module and your mobile devices are addressed on the same sub-network. It means that they have the same broadcast address.



The iAir app is available to free download in Google Play and App Store. Search “iAir” in or search “iAir”, “ICPDAS” in App Store and tap on install.

The iAir user manual can be obtained from

<http://ftp.icpdas.com/pub/cd/usbcd/napdos/dl-300/document/>

7. Utility to Get/Manage Data Log

DL-300 Utility is a convenient, easy-to-use management utility running on Windows platform that allows users to monitor the real-time data and trend chart from DL-300 modules on the Ethernet, it can group the DL-300 modules for group view management, log alarm events with timestamp, download the logged data from a DL-300 logger and export the data to *.csv files for performing statistical analysis in Excel.

The DL-300 Utility can be obtained from:

CD:\Napedos\DL-300\utility\DL300_utility

http://ftp.icpdas.com/pub/cd/usbcd/napedos/dl-300/utility/dl300_utility

1. Run the DL300_utility_setup_YYYYMMDD.exe, the default install location is C:\ICPDAS\DL300_UTILITY\DL-300 Utility

2. Open the DL-300 Utility by double clicking on the DL-300 Utility shortcut on desktop.



3. Search out a DL-300 module on the Ethernet and set the configuration.

3-1. Select the **Device Settings** on the **Settings** menu.

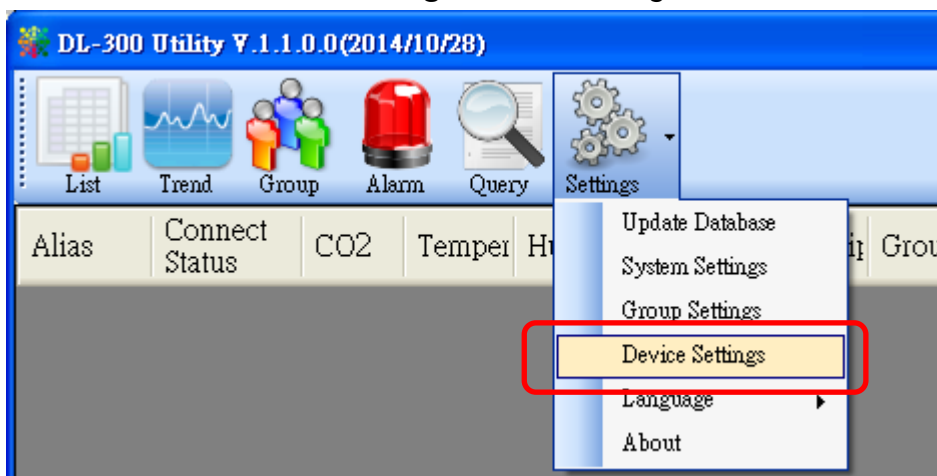

3-2. Click the **Search New Device** button to search the DL-300 modules connected on the same Ethernet network.

3-3. Check the checkbox next to a module and click the **Add** button to add the module in the utility.

3-4. Highlight a module and click the **Edit Device** button to configure the module.

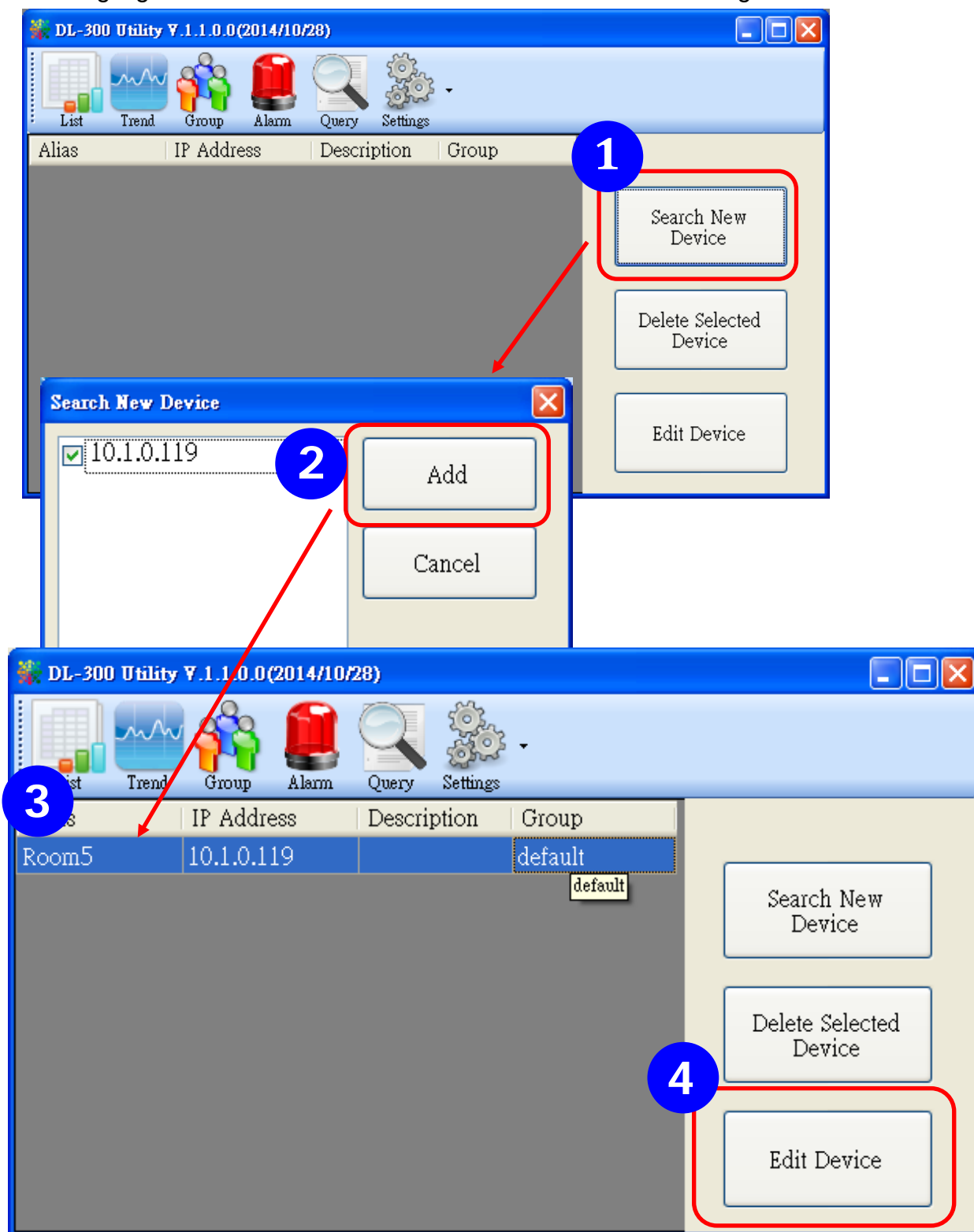

3-5. Set the configuration, and click on the **OK** button.

Note

Consult your network administrator before making changes to IP Address/ Mask Address/ Gateway

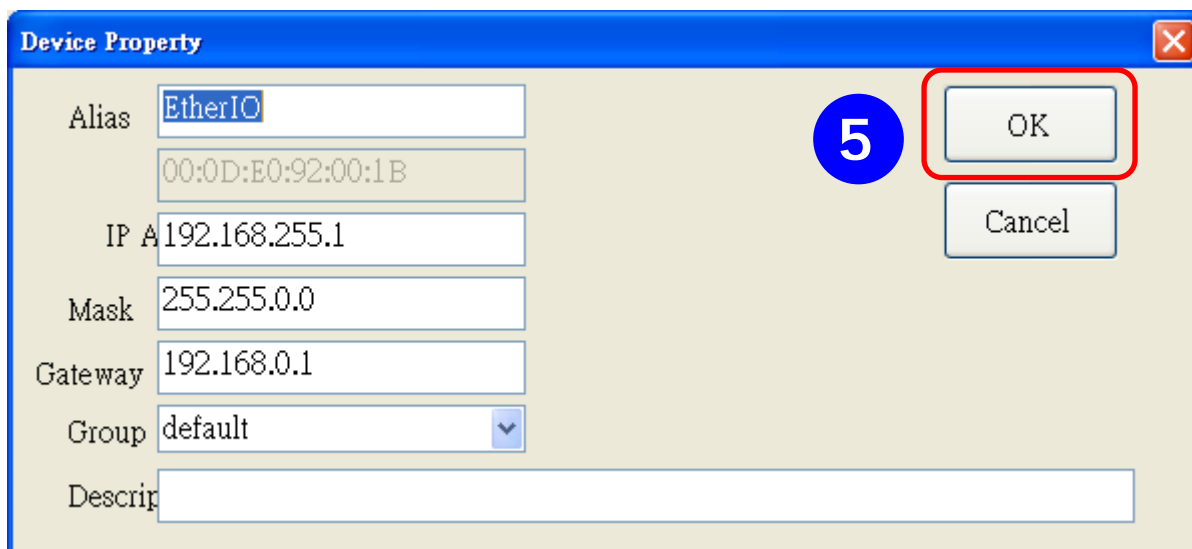

4. Get real-time data, trend chart and alarm event.

4-1. Click the **List** icon to obtain the real-time data. It also lists the connect status, group information and IP address for every DL-300 logger.

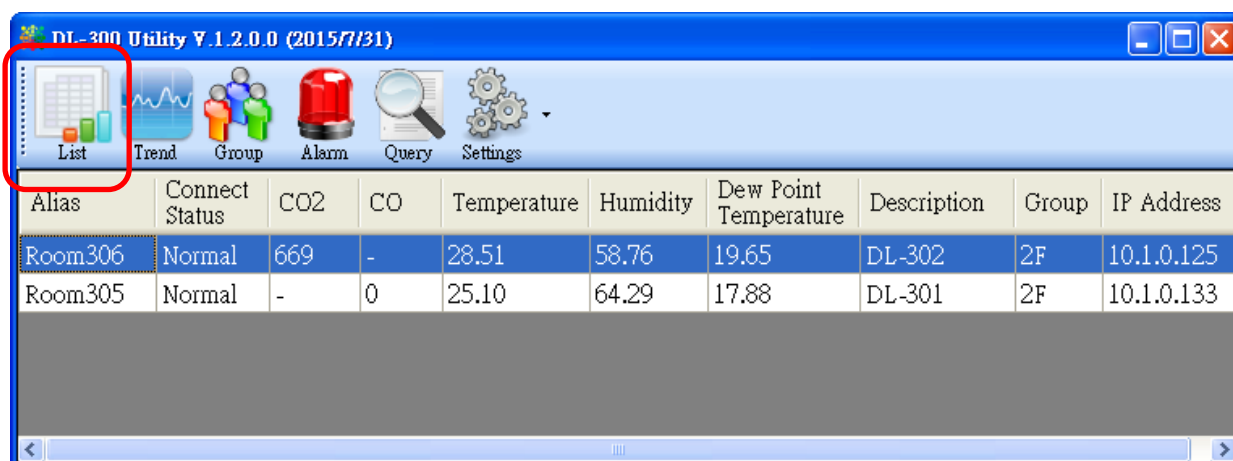

4-2. Click the **Trend** icon to display the trend chart. Users can select the radio button for CO/CO₂ level, Temperature or Humidity to access the trend chart for those real-time data, check the checkbox next to each DL-300 logger to display its trend chart or uncheck it to cancel display. Drag and drop the trend chart can move it to see the data not be displayed in the chart.



4-3. Click the **Alarm** icon to review the alarm events.

Alias	CO2	Temperature	Humidity	Dew Point	Description	Group	IP Address	Alarm
Room8A	901	25.4	62.86	17.8		1F	10.1.0.120	CO2 is over Alert Value at time:2014/11/21
Room8A	904	25.42	62.89	17.83		1F	10.1.0.120	CO2 is over Alert Value at time:2014/11/21
Room8A	899	25.33	62.86	17.74		1F	10.1.0.120	CO2 is over Alert Value at time:2014/11/21
Room8A	898	25.34	62.83	17.74		1F	10.1.0.120	CO2 is over Alert Value at time:2014/11/21
Room1A	796	27.4	56.97	18.11		1F	10.1.0.86	CO2 is over Alert Value at time:2014/11/21
Room1A	795	27.46	56.98	18.17		1F	10.1.0.86	CO2 is over Alert Value at time:2014/11/21
Room1A	792	27.44	56.98	18.15		1F	10.1.0.86	CO2 is over Alert Value at time:2014/11/21
Room1A	794	27.42	56.99	18.14		1F	10.1.0.86	CO2 is over Alert Value at time:2014/11/21
Room1A	791	27.45	56.95	18.15		1F	10.1.0.86	CO2 is over Alert Value at time:2014/11/21
Room1A	793	27.45	56.98	18.16		1F	10.1.0.86	CO2 is over Alert Value at time:2014/11/21

4-4. Modify the event condition.

Select the **System Settings** on the **Settings** menu.

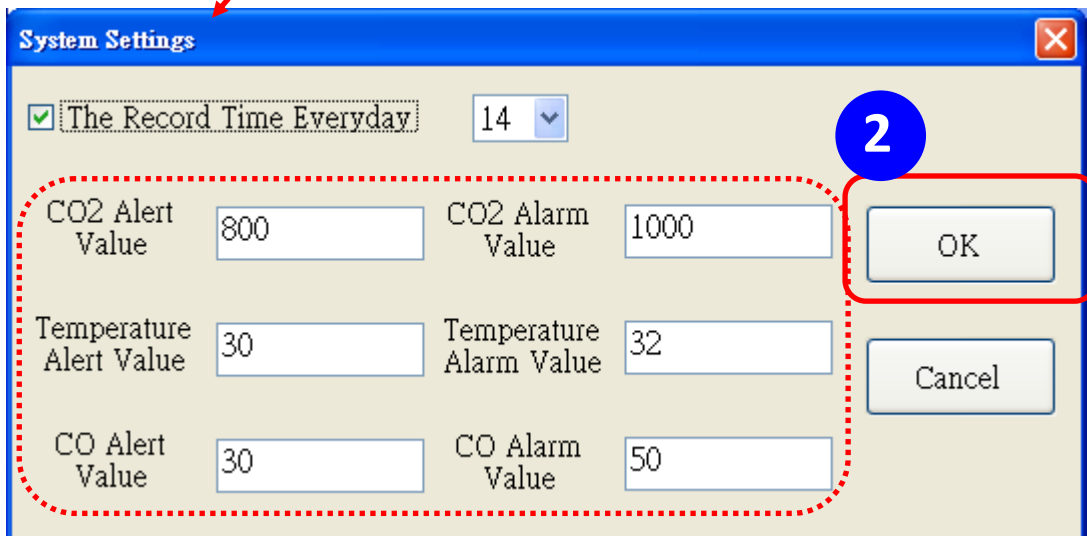
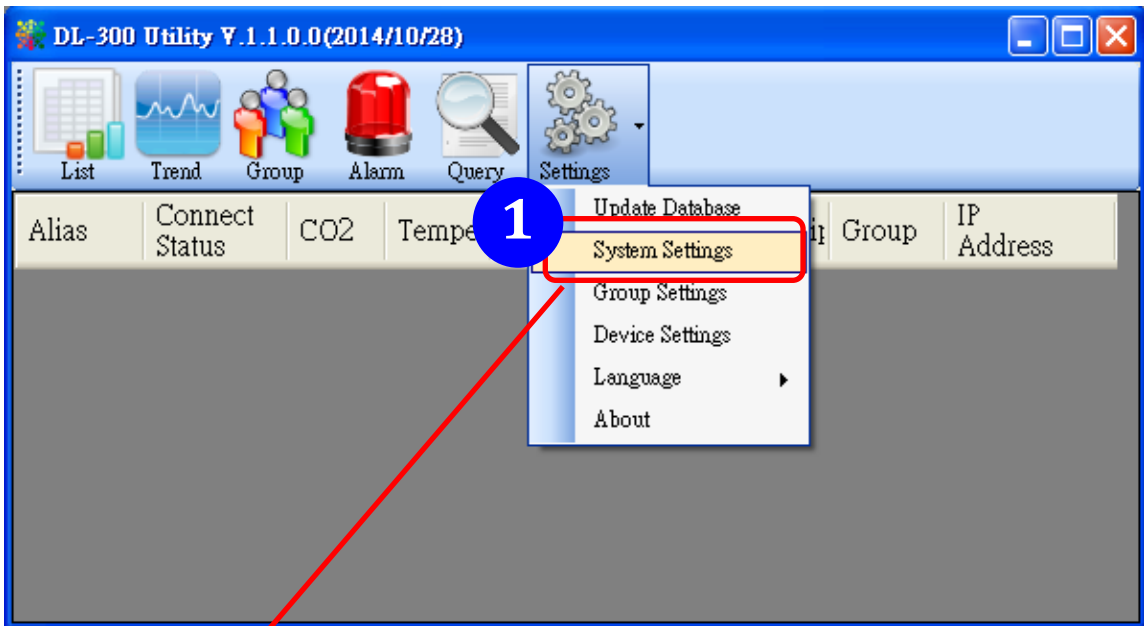

Set the *CO/CO2 Alert Value*, *CO/CO2 Alarm Value* (If it is supported in the logger), *Temperature Alert Value* and *Temperature Alarm Value* for trigger events. Check the checkbox next to *The Record Time Everyday* can schedule auto generate report everyday at the time set in the dropdown menu. Click on the **OK** button to complete the settings.

- 5. Download data in a DL-300 logger and export the data
 - 5.1. Select **Update Database** on the Settings menu
 - 5.2. Click the **Start** button to download the data in DL-300 modules.
 - 5.3. Click the close icon to exit the download procedure when all data are downloaded.

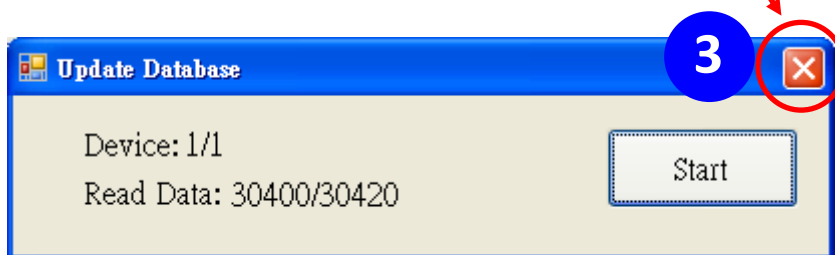
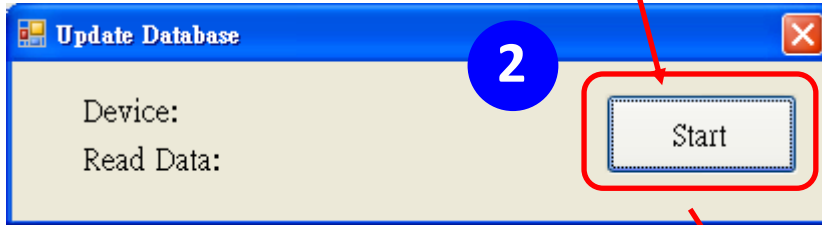
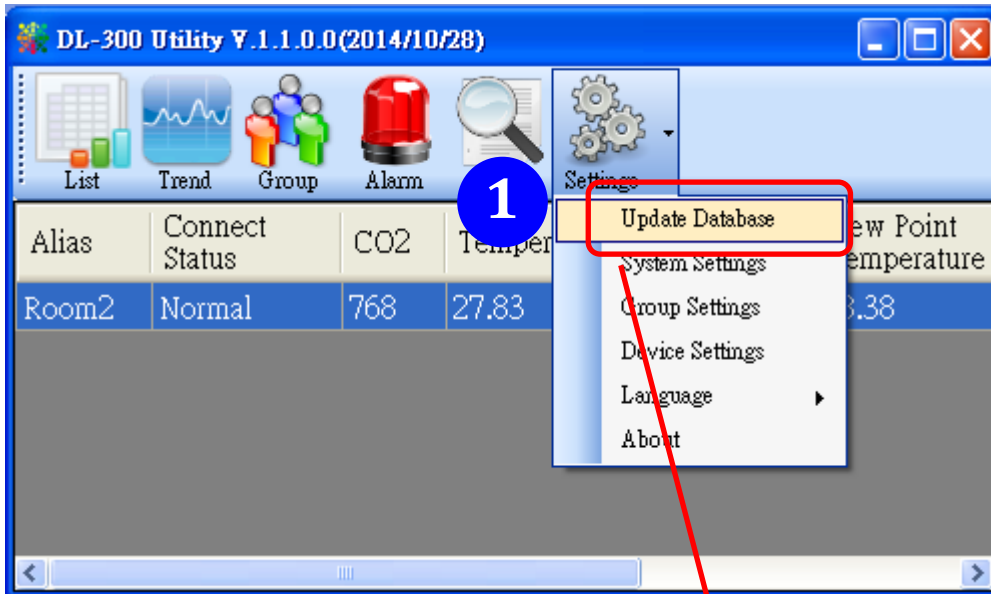

5.4. Click the **Query** icon.

5.5. Highlight the desired module, set the *Start Time* and *End Time*, and then click the **Search** button. The data in the time period will be listed as below.

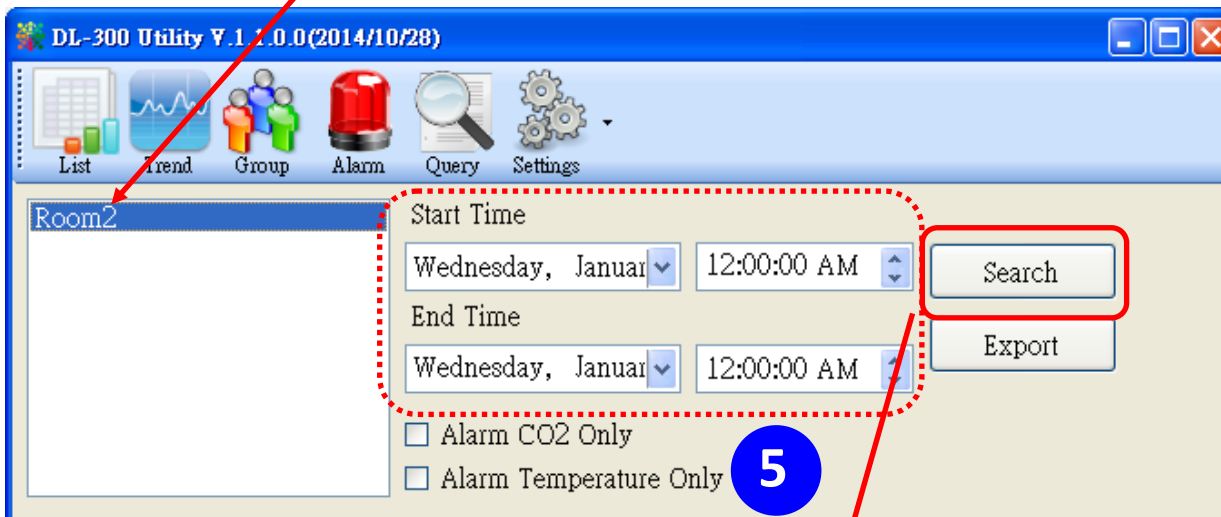
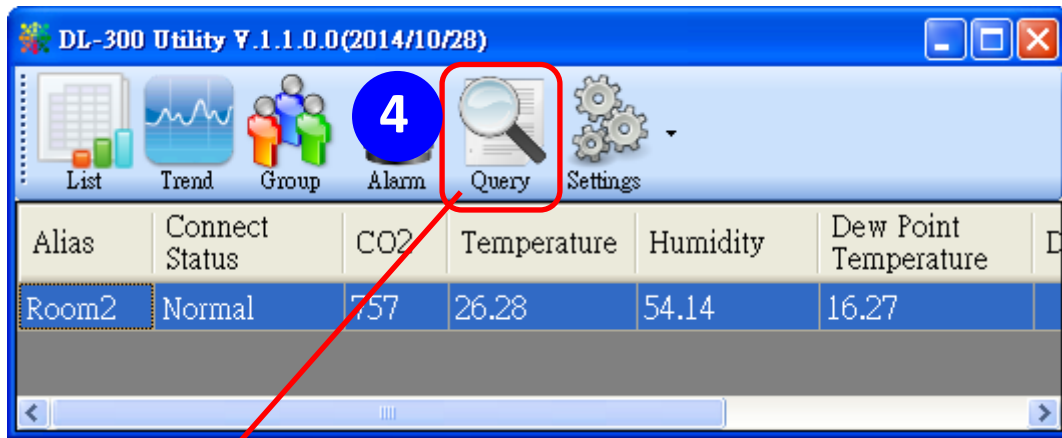

Time	CO2	Humidity	Temperature	Dew Point
2014/11/25 ...	0	67.85	23.19	16.76
2014/11/25 ...	853	66.72	23.42	16.76
2014/11/25 ...	1187	67.29	23.7	17.16
2014/11/25 ...	864	65.07	23.92	16.93
2014/11/25 ...	923	64.83	24.13	17.1
2014/11/25 ...	852	64.34	24.32	17.19
2014/11/25 ...	818	63.25	24.52	17.17
2014/11/25 ...	796	62.58	24.68	17.2

5.6. Click the **Export** button to export the searched data in *.csv files for performing statistical analysis in Excel.

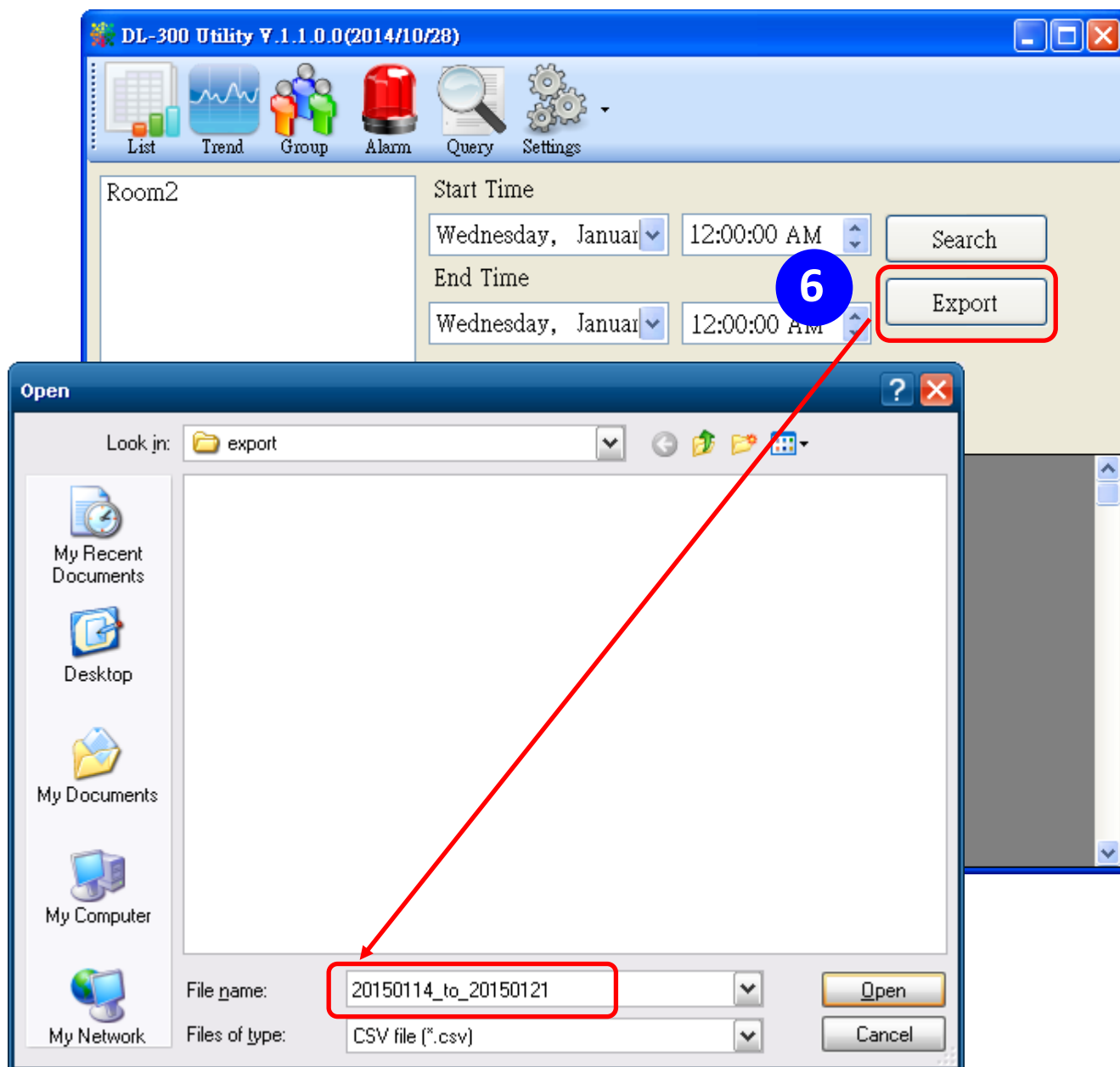

- 6. Group the devices by location or users
 - 6.1. Select **Group Settings** on the Settings menu.

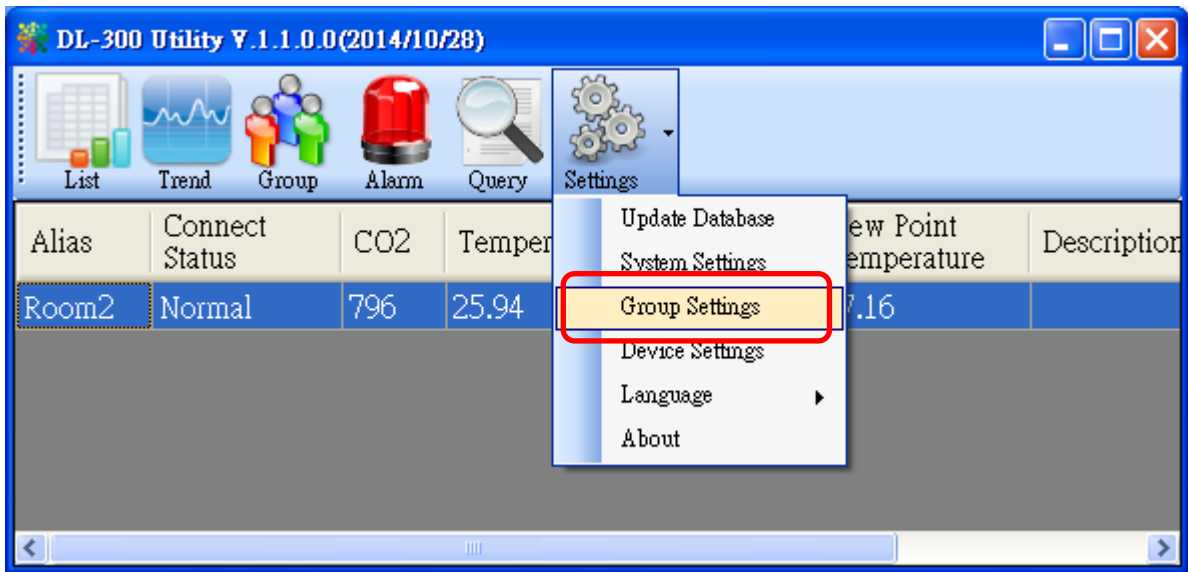

- 6.2 Click the **New** button, enter the group name and click the **OK** button in the pop-up box, and then click the **OK** button in the Group Settings box.

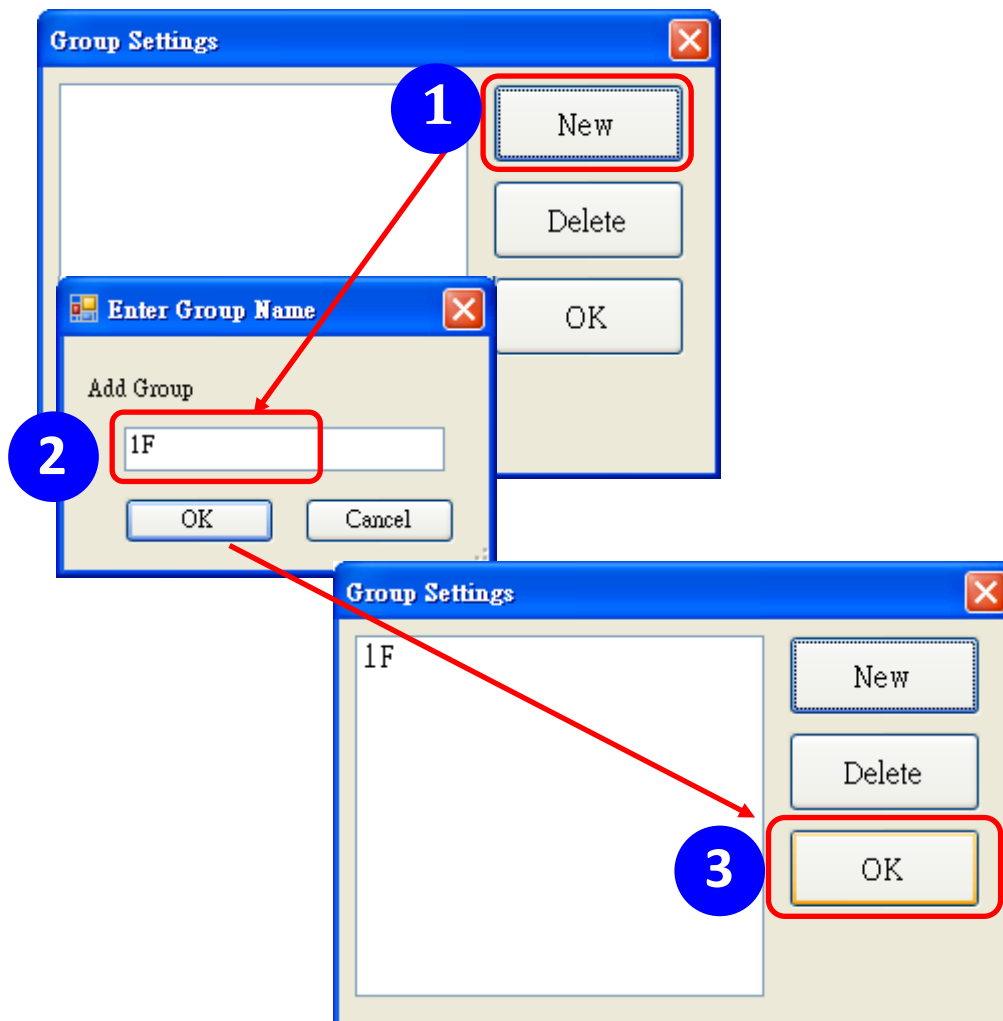

6-3. Select **Device Settings** on the **Settings** menu; highlight the desired device and click the **Edit Device** button, select the group name for the module and click the **OK** button in the pop-up **Device Property** box to complete the setting.

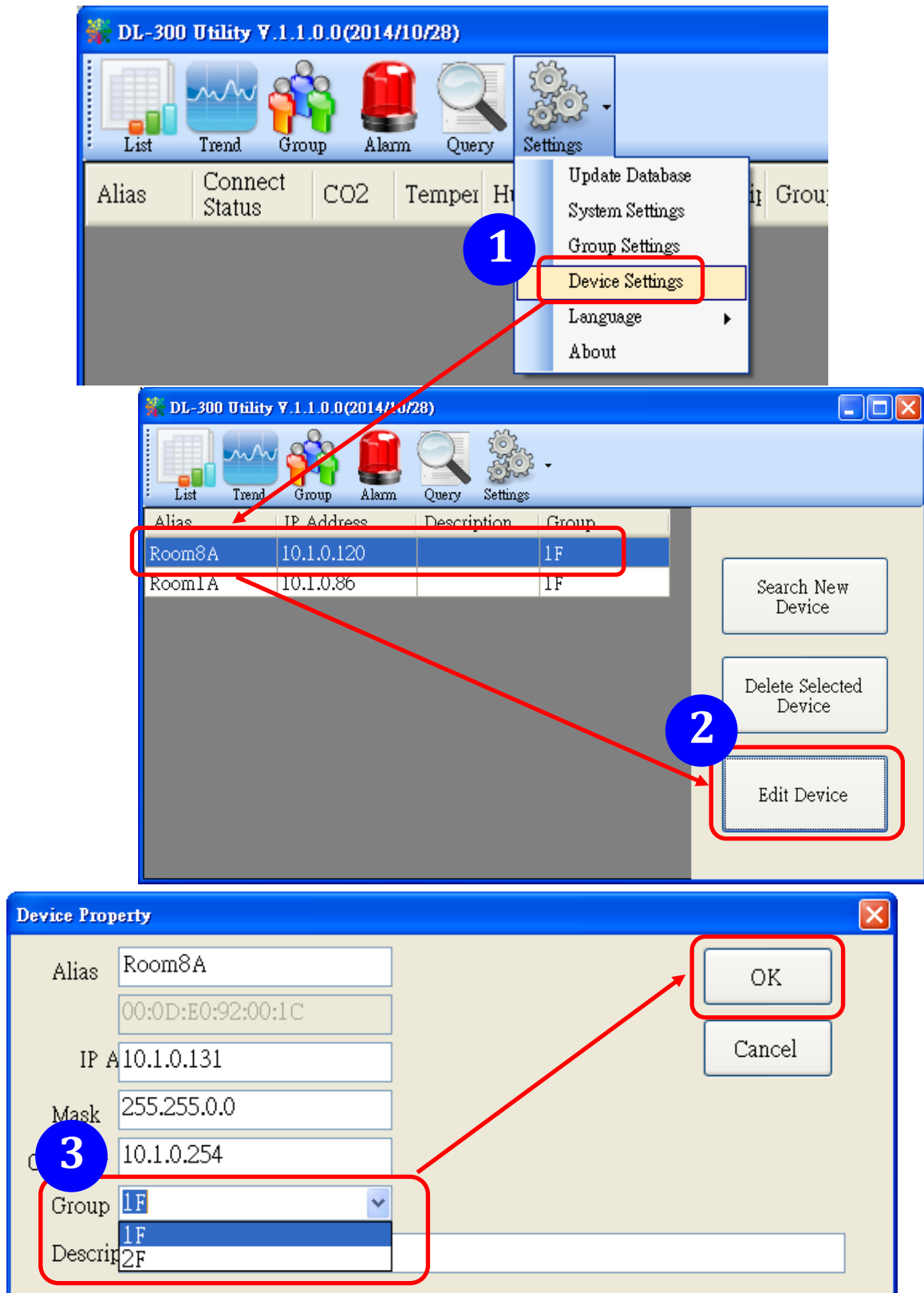

6-4. Monitor the group data by clicking the **Group** icon and then highlighting the group name.

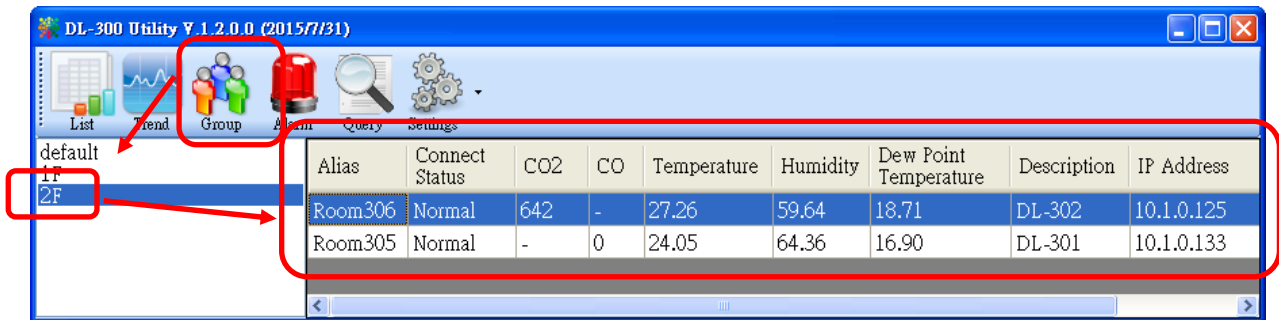

8. FAQ

Q1: What is ABC (Automatic Baseline Correction)?

A: ABC stands for the Automatic Baseline Correction which is used to adjust a shifted baseline to the carbon dioxide level in fresh air. In case of normal indoor application, the carbon dioxide level drops to nearly outside air where there are no human, green plants or anything to elevate the carbon dioxide levels on weekday evenings or weekends, the ABC algorithm constantly keeps track of the lowest reading and slowly corrects it as the expected value in fresh air typically around 400 ppm.

Q2: Why I need to enable the ABC?

A: When the CO₂ concentration detected in a period time of unoccupied space is greater than the base value of 400ppm, enable the ABC function to adjust the baseline. Be careful that the ABC will not work if a space is constantly occupied such as a hospital, 24-hr factory, 24-hr store, green house or other applications where CO₂ levels may be elevated at all times.

Q3: Does the DL-302/DL-303 enable the ABC as the factory default setting?

A3: No, the ABC is default disabled in a DL-302/DL-303 logger to prevent the baseline from being adjusted to an incorrect value in case of using in a constantly occupied space.

Q4: What to do when the ABC is no work?

A4: When the ABC is no work regarding baseline correction, the DL-302/DL-303 needs be returned to ICP DAS.

Q5: How to set the touch password?

A5: Enter the IP address for your DL-300 logger in the address bar of a web browser and go to the Change Password page, enter the password in the New password and Confirm new password in the Change Touch Password field and then press the Submit button for change touch password. The password is numbers from 0 to 9 and up to 8 digits.

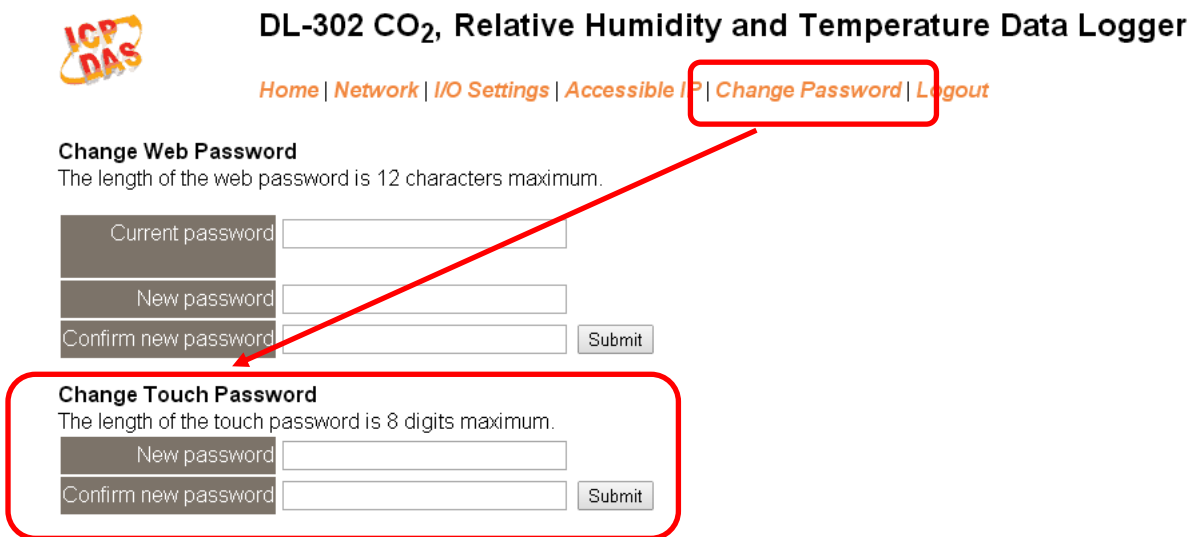

Once the password is set, the password will be requested whenever users want to enter the setting menu from the touch screen.

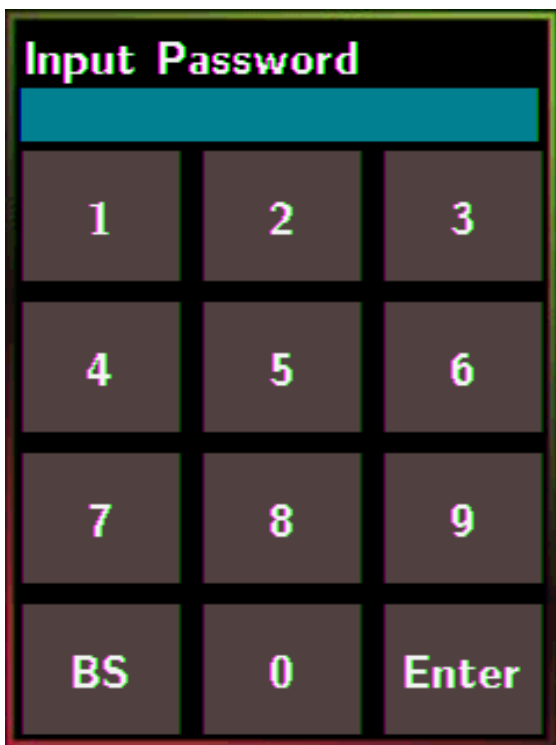

Q6: How to cancel the touch password?

A6: Enter the IP address for your logger in the address bar of a web browser and go to the Change Password page, keep the New password and Confirm new password in Change Touch Password field empty and then press the Submit button for change touch password.

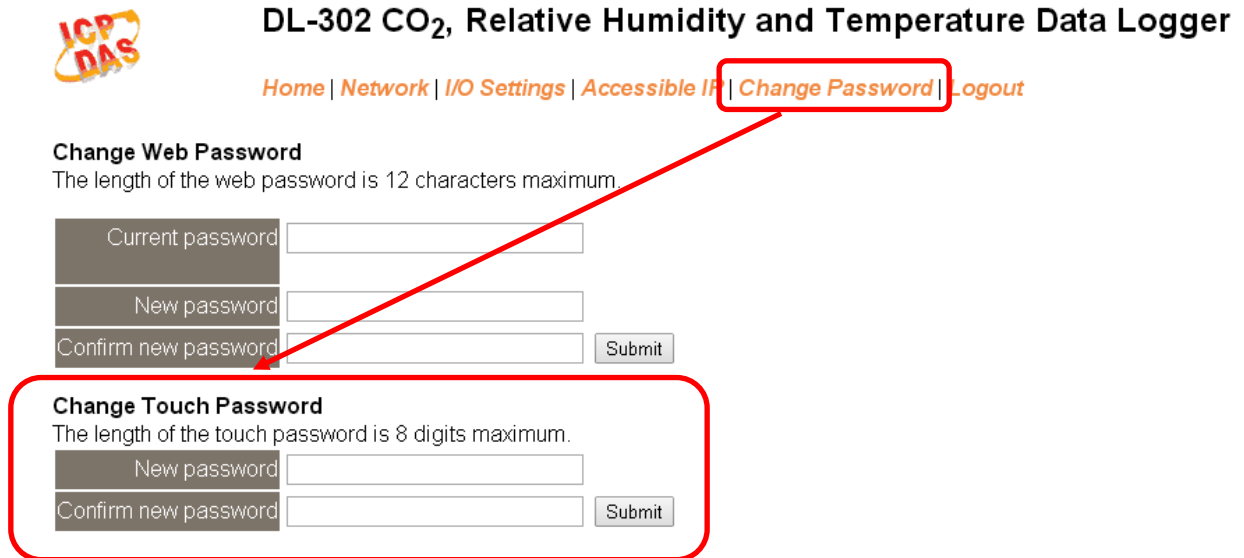

ICP DAS **DL-302 CO₂, Relative Humidity and Temperature Data Logger**

[Home](#) | [Network](#) | [I/O Settings](#) | [Accessible IP](#) | **[Change Password](#)** | [Logout](#)

Change Web Password
The length of the web password is 12 characters maximum.

Current password

New password

Confirm new password

Change Touch Password
The length of the touch password is 8 digits maximum.

New password

Confirm new password

Q7: How to set the Accessible IP?

A7: Enter the IP address for your logger in the address bar of a web browser and go to the *Accessible IP Settings* page, select the radio button next to *Add ____ . ____ . ____ . ____ To The List* and key in the IP for a device which is allowed to access the DL-300, and then click the submit button.

Check the checkbox next to the *Save to Flash* before clicking the *submit* button to save the IP setting and use after repowering. Once any of those in the list is set, only the device for which the IP address is saved in the list can assess the DL-300.

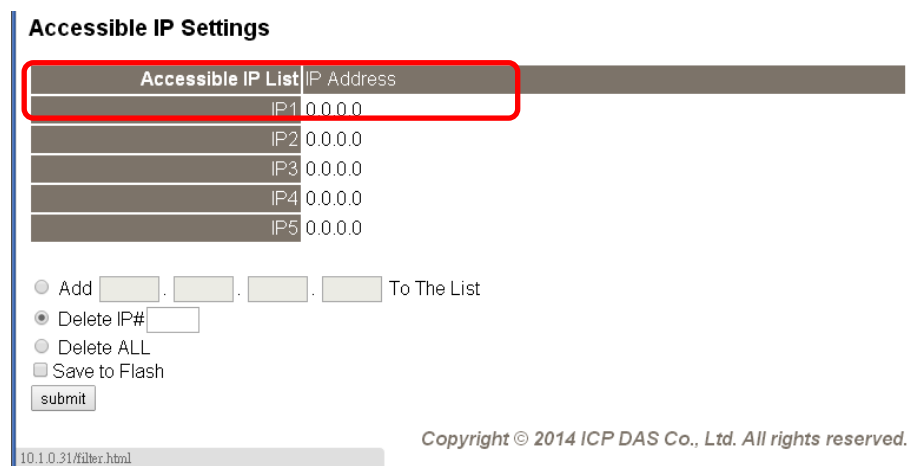

Accessible IP Settings

Accessible IP List	IP Address
<input type="radio"/>	IP1 0.0.0.0
<input type="radio"/>	IP2 0.0.0.0
<input type="radio"/>	IP3 0.0.0.0
<input type="radio"/>	IP4 0.0.0.0
<input type="radio"/>	IP5 0.0.0.0

Add . . . To The List

Delete IP#

Delete ALL

Save to Flash

10.1.0.31/filter.html Copyright © 2014 ICP DAS Co., Ltd. All rights reserved.

Q8: How to delete the Accessible IP settings?

A8: Enter the IP address for your logger in the address bar of a web browser and go to the *Accessible IP Settings* page, select the radio button next to Delete IP# to delete a IP by the IP number or select the radio button next tot Delete All and then click the submit button.

Check the checkbox next to the *Save to Flash* before clicking the *submit* button to save the IP setting and use after repowering.

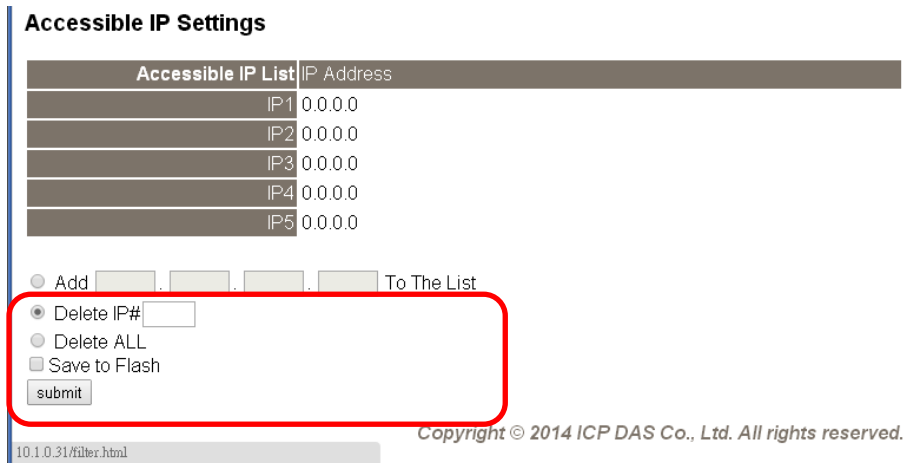

Q9: How to clear the data logged in a DL-300 module?

A9: Enter the IP address for the module in the address bar of a web browser and go to the *I/O Settings* page, click the Reset Data Logger button at the bottom of the page.



Q10: How to calibrate the touch screen?

A10:

1. Set the *pin 3. Touch Calib* in ON position and others in OFF position on SW1.
2. Power on the DL-300 module
3. Touch the white boxes displayed in turn.

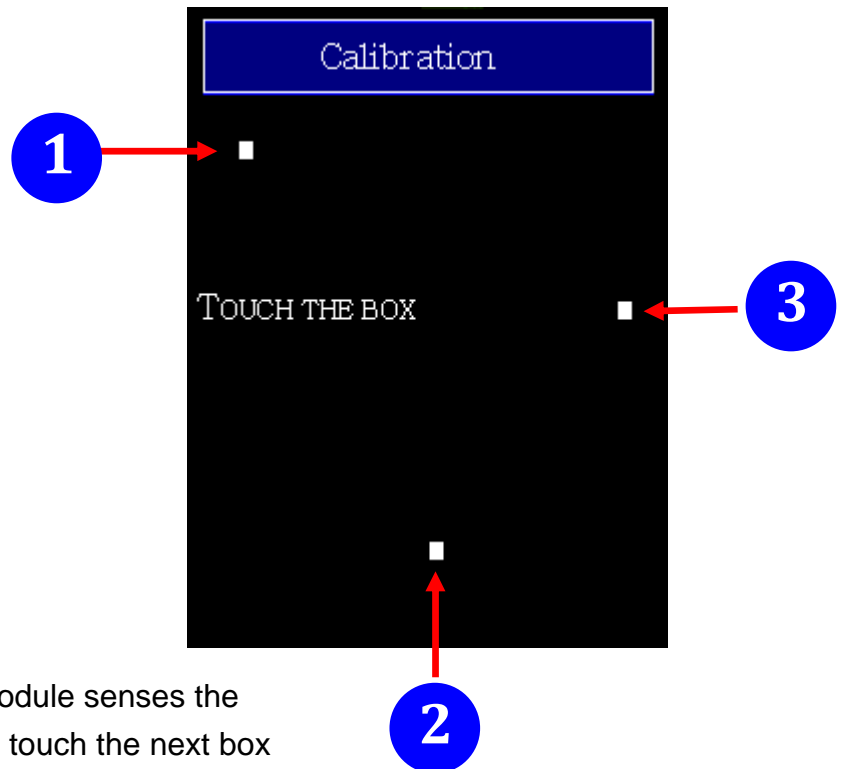

4. Touch one blue box, till the module senses the touch input and sounds. Then touch the next box one by one till the 5 five boxes are sensed.

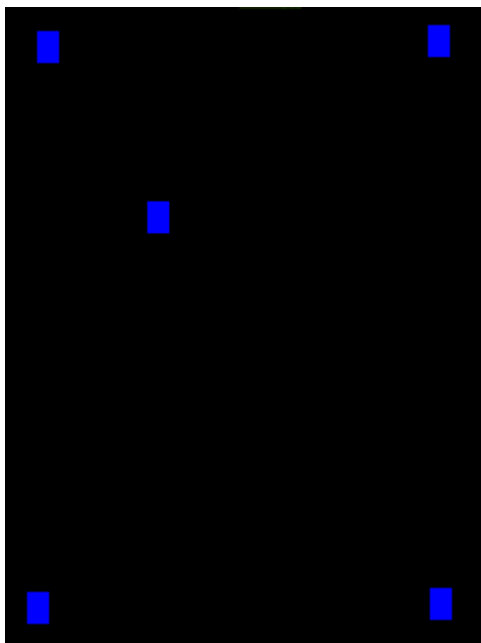

Note:

After the 5 boxes are sensed, the screen turns to homescreen and calibration is complete. Please note to set *pin 3. Touch Calib* in OFF position and reboot the module.

If the calibration is failed and the screen does not turn to homescreen, re-power-cycle the module and restart calibration process.

Q11: How to download firmware into a DL-300 module?

To determine the version of firmware of a DL-300, tap the About item in the Settings menu to enter the sub-menu.



Steps for downloading firmware:

1. Download the USB driver and the latest firmware from <http://ftp.icpdas.com/pub/cd/usbcd/napdos/dl-300/firmware>
2. Install the USB driver ◦
4. Connect the DL-300 module and computer by using USB cable.
3. Set the *pin 2. FW Update* in ON position on SW1 as below.

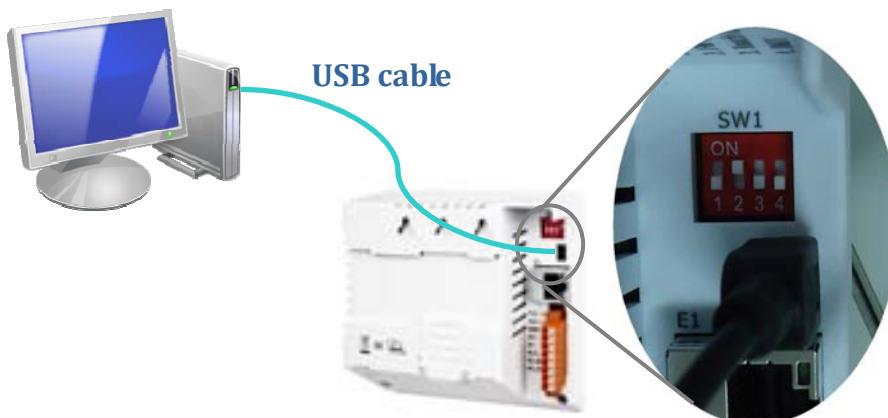

5. Power on the DL-300, it will show white screen.
6. Run **DL-302_Bxx.bat** (Bxx is the version of firmware), wait the process finish (for example, from 1/238 to 238/238), and then close the cmd.exe window.

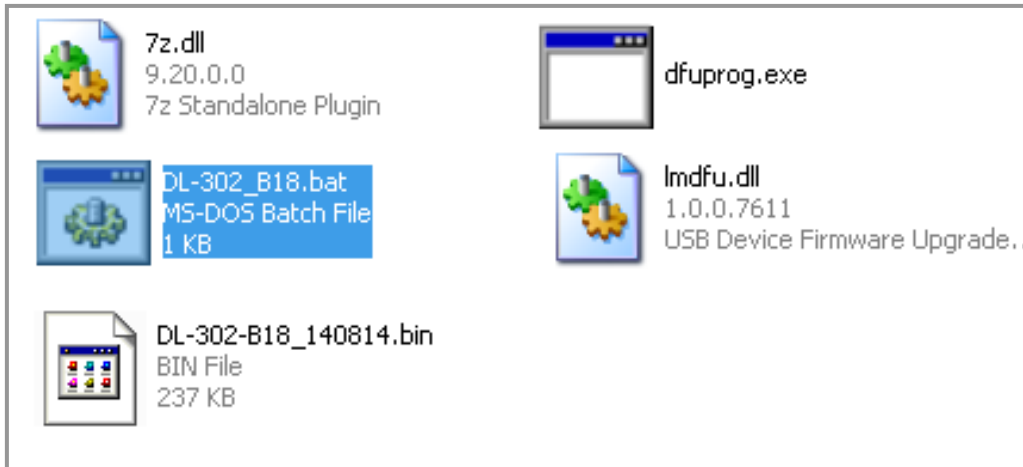

```

C:\WINDOWS\system32\cmd.exe
T:\install area\d1302_fw>rem dfu gcc\TouchOS.bin
T:\install area\d1302_fw>rem D:\HMIWorks\HMIWorks_Standard\bin\dfuprog.exe gcc\T
ouchOS.bin
T:\install area\d1302_fw>dfuprog.exe -a 0x1800 -f DL-302-B18_140814.bin
USB Device Firmware Upgrade Example
Copyright (c) 2008-2011 Texas Instruments Incorporated. All rights reserved.
Scanning USB buses for supported DFU devices...
Downloading DL-302-B18_140814.bin to device...
1/238
2/238
3/238
4/238
5/238
6/238
7/238
8/238
9/238
10/238
11/238
12/238
13/238
...

```

7. Set the *pin 2. FW Update* in OFF position on SW1, remove the USB cable and repower on the module.
8. Go to the About sub-menu in the module to make sure the firmware version.



Q12: How to display message on the DL-300 with Modbus command?

A12: The message can be pre-saved in the DL-300 or directly displayed on the screen. Writing the index number for a pre-saved message to Modbus address 40861 (based 1) can display the message. The time for display message is set in the address 40859, ranged from 1 to 65535 in seconds.

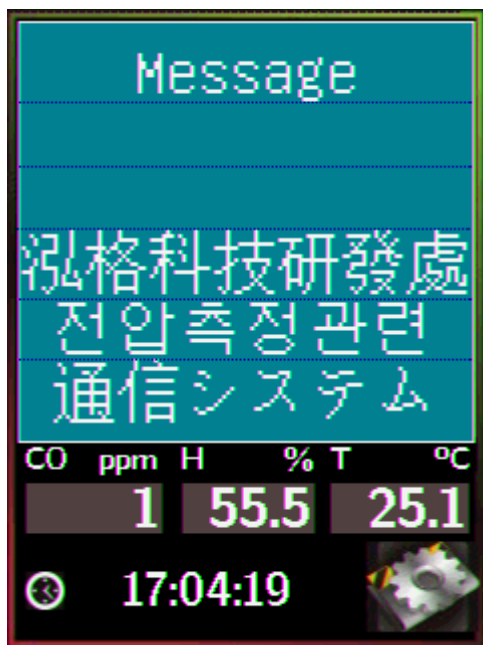

The display-message-on-screen function supports multiple language character sets based on UTF-8 encoding. A message can have a maximum of 6 lines and 14 half-width characters or 7 full-width characters maximum each line.

The background color, text color, text alignment, buzzer prompt sound, and acknowledge button are configurable for users' requirements.

▶ **Setting the display time**

Holding Register (4xxxx, base 1)

Address	Description	Attribute
40859	Sets the time for displaying message, ranged from 1 to 65535 in seconds. 0 = displays message until a stop command received	R/W

▶ **Displaying a pre-saved message**

The DL-300 is able to save a maximum of 20 messages with an individual index. Write the index to address 40861 to display the message and write 65535 to stop the display and return to the home screen.

Holding Register (4xxxx, base 1)

Address	Description	Attribute
40861	Write the index to display a pre-saved message. 0 ~ 19: the message index, 65535: stop displaying message.	R/W

► **Saving a message or displaying a dynamic message**

Modbus command: Write Multiple Registers (10h)

Modbus address: 450302 (C47Dh, base 1)

Data format: 'IM' + Message Index + Message String + Message Settings

Byte	0	1	2	3	4	N-1	N	N+1
	Delimiter		Index	Message String				Message Settings
Data	I (0x49)	M (0x4D)	0 ~ 20	T	u	0	M (0x4D)	I (0x49)

1. Delimiter characters: IM

2. Index

The message with the index in the range of 0 to 19 will be saved in the DL-300. If the index is assigned to 20, the followed message will be directly displayed and will not be saved.

3. Message String

A message can have a maximum of 6 lines and 14 half-width characters or 7 full-width characters maximum each line. “\r” (0x0D) is used to do a new line. If the length of a message string is odd, an end character “0” must be added.

4. Message Settings

The Message Settings is optional; at least one zero character must be added between the message string and message settings.

Byte	N	N+1	MSB	N+2				LSB	N+3	N+4	N+5
Data	Delimiter		0	0	0	0	0	X	Y	Background Color	
	M (0x4D)	I (0x49)	Y: Beep, 0: OFF,1: ON					Red	Green	Blue	
			X: Exit button, 0: Hide,1: Display					0~255	0~255	0~255	

Delimiter Characters: MI

N+2: Sets whether to use beep prompt sound and exit button.

Background Color and Text Color: the color is expressed as a 24-bit RGB triplet, each component of which can vary from 0 to 255.

Byte	N+6	N+7	N+8	N+9	N+10	N+11	N+12	N+13
Data	The text color and alignment for the first line				The text color and alignment for the second line			
	0: left 1: center 2: right	Red 0~255	Green 0~255	Blue 0~255	0: left 1: center 2: right	Red 0~255	Green 0~255	Blue 0~255

Byte	N+14	N+15	N+16	N+17	N+18	N+19	N+20	N+21
Data	The text color and alignment for the third line				The text color and alignment for the fourth line			
	0: left 1: center 2: right	Red 0~255	Green 0~255	Blue 0~255	0: left 1: center 2: right	Red 0~255	Green 0~255	Blue 0~255

Byte	N+22	N+23	N+24	N+25	N+26	N+27	N+28	N+29
Data	The text color and alignment for the fifth line				The text color and alignment for the sixth line			
	0: left 1: center 2: right	Red 0~255	Green 0~255	Blue 0~255	0: left 1: center 2: right	Red 0~255	Green 0~255	Blue 0~255

Example:

1. Modbus function: Write Multiple Registers (10h)
2. Modbus address: 450302 (C47Dh, base 1)
3. Description: save the message with Index=0, message content "Hello, world!", buzzer prompt sound ON, Exit button displayed, background color:  (RGB triplet : 008394h), all lines are text color white and left-aligned.

Byte	0	1	2	3	4	5	6	7	8
Data	H	E	L	L	O	,			
Byte	9	10	11	12	13	14	15	16	17
Data	w	o	r	l	d	!	0	M	I
Byte	18	19	20	21	22	23	24	25	26
Data	3	0	131	148	0	255	255	255	0
Byte	27	28	29	30	31	32	33	34	35
Data	255	255	255	0	255	255	255	0	255
Byte	36	37	38	39	40	41			
Data	255	255	0	255	255	255			

Appendix A: DCON Command Sets

A-1. DL-301 DCON Command Sets

Command	Description
\$AAF	Reads firmware version, AA is the RS-485 address (hex).
\$AAI	Reads INIT status, AA is the RS-485 address (hex). response: !AA0 -> INIT short to GND !AA1 -> else
\$AAM	Reads module name, AA is the RS-485 address (hex).
\$AAP	Reads Modbus RTU/DCON protocol. response: !AA0 -> DCON !AA1 -> Modbus RTU
\$AAPN	Sets Modbus RTU/DCON protocol N-> 0: DCON, 1: Modbus RTU
\$AA2	Reads configuration, AA is the RS-485 address (hex).
\$AA5	Reads reset status !AA1 first after power on, !AA0 others
#AA	Read All Analog Inputs response >(CO in 1 ppm)(relative humidity in 0.01%)(temperature in 0.01°C)(temperature in 0.01°F) (dew point temperature in 0.01°C)(dew point temperature in 0.01°F)
#AAN	Reads Channel Analog Input N = 0 for CO in 1 ppm, 1 for relative humidity in 0.01%, 2 for temperature in 0.01°C, 3 for temperature in 0.01°F, 4 for dew point temperature in 0.01°C, 5 for dew point temperature in 0.01°F
%AANNTTCCFF	Sets configuration, AA: current address NN: new address, TT = 00,

	<p>CC: new baud rate</p> <p>Bits 5:0</p> <p>Baud rate, 0x03 ~ 0x0A</p> <table border="1"> <tr> <td>Code</td> <td>0x03</td> <td>0x04</td> <td>0x05</td> <td>0x06</td> </tr> <tr> <td>Baud</td> <td>1200</td> <td>2400</td> <td>4800</td> <td>9600</td> </tr> <tr> <td>Code</td> <td>0x07</td> <td>0x08</td> <td>0x09</td> <td>0x0A</td> </tr> <tr> <td>Baud</td> <td>19200</td> <td>38400</td> <td>57600</td> <td>115200</td> </tr> </table> <p>Bits 7:6</p> <p>00: no parity, 1 stop bit (N,8,1) 01: no parity, 2 stop bits (N,8,2) 10: even parity, 1 stop bit (E,8,1) 11: odd parity, 1 stop bit (O,8,1)</p> <p>FF: data format</p> <p>Bit 6</p> <p>0: checksum disabled 1: checksum enabled</p>	Code	0x03	0x04	0x05	0x06	Baud	1200	2400	4800	9600	Code	0x07	0x08	0x09	0x0A	Baud	19200	38400	57600	115200
Code	0x03	0x04	0x05	0x06																	
Baud	1200	2400	4800	9600																	
Code	0x07	0x08	0x09	0x0A																	
Baud	19200	38400	57600	115200																	
@AABA	<p>Read beep on alarm time response</p> <p>!AAHH, HH in hex, 0: disabled, 1 ~ 250: beep on alarm time in seconds, 251: beep on alarm continuously</p>																				
@AABAHH	<p>Set beep on alarm, HH in hex, 0: disabled, 1 ~ 250: beep on alarm time in seconds, 251: beep on alarm continuously</p>																				
@AABL	<p>Read LCD back light response</p> <p>!AAHH, HH: 00 ~ FF in hex</p>																				
@AABLHH	<p>Set LCD back light, HH: 00 ~ FF in hex</p>																				
@AACH	<p>Clear all high latched analog inputs to the current values</p>																				

Command	Description
@AACHN	Clear channel high latched analog input to the current value N = 0 for CO, 1 for relative humidity, 2 for temperature in 0.01°C, 3 for temperature in 0.01°F, 4 for dew point temperature in 0.01°C, 5 for dew point temperature in 0.01°F
@AACHCN	Clear high latched alarm of a channel, N = 0 for CO, 1 for relative humidity, 2 for temperature in 0.01°C, 3 for temperature in 0.01°F, 4 for dew point temperature in 0.01°C, 5 for dew point temperature in 0.01°F
@AACL	Clear all low latched analog inputs to the current values
@AACLN	Clear channel low latched analog input to the current value N = 0 for CO, 1 for relative humidity, 2 for temperature in 0.01°C, 3 for temperature in 0.01°F, 4 for dew point temperature in 0.01°C, 5 for dew point temperature in 0.01°F
@AACL CN	Clear low latched alarm of a channel, N = 1 for relative humidity, 2 for temperature in 0.01°C, 3 for temperature in 0.01°F, 4 for dew point temperature in 0.01°C, 5 for dew point temperature in 0.01°F
@AADACN	Disable AI alarm of a channel, N = 0 for CO, 1 for relative humidity, 2 for temperature in 0.01°C, 3 for temperature in 0.01°F, 4 for dew point temperature in 0.01°C, 5 for dew point temperature in 0.01°F
@AADI	read DO

	response !AA00000
@AADO0V	set DO, V-> 0: off, 1: on
@AAEATCN	Enable AI alarm of a channel, N = 0 for CO, 1 for relative humidity, 2 for temperature in 0.01°C, 3 for temperature in 0.01°F, 4 for dew point temperature in 0.01°C, 5 for dew point temperature in 0.01°F T->M: momentary alarm mode, L: latched alarm mode
@AAHI(data)CN	Set high alarm limit of an AI channel, N = 0 for CO in 1ppm, 1 for relative humidity in 0.01%, 2 for temperature in 0.01°C, 3 for temperature in 0.01°F, 4 for dew point temperature in 0.01°C, 5 for dew point temperature in 0.01°F
@AAHO	Read humidity offset
@AAHO(data)	Set humidity offset, data in format of -100.00 ~ +100.00
@AALO(data)CN	Set low alarm limit of an AI channel, N = 1 for relative humidity in 0.01%, 2 for temperature in 0.01°C, 3 for temperature in 0.01°F, 4 for dew point temperature in 0.01°C, 5 for dew point temperature in 0.01°F
@AARACN	Read AI alarm enabled/disabled status of a channel response !AAN, N->0: disabled, 1: momentary, 2: latched

Command	Description
@AARAO	Read AI alarm status response !AAHLL
@AARH	Read all high latched values of analog input channels response >(CO in 1 ppm)(relative humidity in 0.01%)(temperature in 0.01°C)(temperature in 0.01°F)(dew point temperature in 0.01°C)(dew point temperature in 0.01°F)
@AARHN	Read channel high latched value of analog input N = 0 for CO in 1 ppm, 1 for relative humidity in 0.01%, 2 for temperature in 0.01°C, 3 for temperature in 0.01°F, 4 for dew point temperature in 0.01°C, 5 for dew point temperature in 0.01°F
@AARHCN	Read high alarm limit of an AI channel N = 0 for CO in 1 ppm, 1 for relative humidity in 0.01%, 2 for temperature in 0.01°C, 3 for temperature in 0.01°F, 4 for dew point temperature in 0.01°C, 5 for dew point temperature in 0.01°F
@AARL	Read all low latched values of analog input channels response >(CO in 1 ppm)(relative humidity in 0.01%)(temperature in 0.01°C)(temperature in 0.01°F)(dew point temperature in 0.01°C)(dew point temperature in 0.01°F)
@AARLN	Read channel low latched value of analog input N = 0 for CO in 1 ppm, 1 for relative humidity in 0.01%, 2 for temperature in 0.01°C, 3 for temperature in 0.01°F, 4 for dew point temperature in 0.01°C, 5 for dew point temperature in 0.01°F
@AARLCN	Read low alarm limit of an AI channel N = 1 for relative humidity in 0.01%, 2 for temperature in 0.01°C,

	3 for temperature in 0.01°F, 4 for dew point temperature in 0.01°C, 5 for dew point temperature in 0.01°F
@AART	Read RTC data
@AARTYYMMD DHHMMSS	Set RTC data
@AASS	Read screen saver time
@AASSHHHH	Set screen saver time in seconds in hex format, 0000h to FFFFh, 0000 to disable
@AATO	Read temperature offset in 0.01°C
@AATO(data)	Set temperature offset in 0.01°C, -100.00 ~ +100.00
~**	clear host watchdog timeout counter
~AA0	read host watchdog status
~AA1	clear host watchdog timeout status
~AA2	read host watchdog enable/disable status and timeout value
~AA3ETT	enable/disable host watchdog and set timeout value E-> 0: disable host watchdog, 1: enable host watchdog TT: host watchdog timeout in 0.1s in hex format
~AA4	read DO power on and safe value
~AA50P0S	set DO power on and safe value P-> 0: power on value off, 1: power on value on S-> 0: safe value off, 1: safe value on
~AARD	read response delay time in ms in hex format
~AARDVV	set response delay time in ms, VV in hex format, 00 - 1E

A-2. DL-302 DCON Command Sets

Command	Description
\$AAF	read firmware version
\$AAI	read INIT status response: !AA0 -> INIT short to GND !AA1 -> else
\$AAM	read module name
\$AAP	Read Modbus RTU/DCON protocol response: !AA0 -> DCON !AA1 -> Modbus RTU
\$AAPN	Set Modbus RTU/DCON protocol N-> 0: DCON, 1: Modbus RTU
\$AA2	read configuration
\$AA5	read reset status !AA1 first after power on, !AA0 others
#AA	Read All Analog Inputs response >(CO ₂ in 1 ppm)(relative humidity in 0.01%)(temperature in 0.01°C)(temperature in 0.01°F) (dew point temperature in 0.01°C)(dew point temperature in 0.01°F)
#AAN	Read Channel Analog Input N = 0 for CO ₂ in 1 ppm, 1 for relative humidity in 0.01%, 2 for temperature in 0.01°C, 3 for temperature in 0.01°F, 4 for dew point temperature in 0.01°C, 5 for dew point temperature in 0.01°F
%AANNTTCCFF	set configuration, AA: current address, NN: new address, TT = 00,

	<p>CC: new baud rate</p> <p>Bits 5:0 : Baud rate, 0x03 ~ 0x0A</p> <table border="1"> <tr> <th>Code</th> <th>0x03</th> <th>0x04</th> <th>0x05</th> <th>0x06</th> </tr> <tr> <td>Baud</td> <td>1200</td> <td>2400</td> <td>4800</td> <td>9600</td> </tr> <tr> <th>Code</th> <th>0x07</th> <th>0x08</th> <th>0x09</th> <th>0x0A</th> </tr> <tr> <td>Baud</td> <td>19200</td> <td>38400</td> <td>57600</td> <td>115200</td> </tr> </table> <p>Bits 7:6</p> <p>00: no parity, 1 stop bit (N,8,1) 01: no parity, 2 stop bits (N,8,2) 10: even parity, 1 stop bit (E,8,1) 11: odd parity, 1 stop bit (O,8,1)</p> <p>FF: data format</p> <p>Bit 6</p> <p>0: checksum disabled 1: checksum enabled</p>	Code	0x03	0x04	0x05	0x06	Baud	1200	2400	4800	9600	Code	0x07	0x08	0x09	0x0A	Baud	19200	38400	57600	115200
Code	0x03	0x04	0x05	0x06																	
Baud	1200	2400	4800	9600																	
Code	0x07	0x08	0x09	0x0A																	
Baud	19200	38400	57600	115200																	
@AAABC	<p>Read status of the automatic baseline correction response</p> <p>!AAN, N=0: disabled, 1: enabled</p>																				
@AAABCN	<p>Set the automatic baseline correction</p> <p>N->0: disabled, 1: enabled</p>																				
@AABA	<p>Read beep on alarm time response</p> <p>!AAHH, HH in hex, 0: disabled, 1 ~ 250: beep on alarm time in seconds, 251: beep on alarm continuously</p>																				
@ABAHH	<p>Set beep on alarm, HH in hex,</p> <p>0: disabled, 1 ~ 250: beep on alarm time in seconds, 251: beep on alarm continuously</p>																				
@AABL	<p>Read LCD back light response</p> <p>!AAHH, HH: 00 ~ FF in hex</p>																				
@AABLHH	<p>Set LCD back light, HH: 00 ~ FF in hex</p>																				
@AACH	<p>Clear all high latched analog inputs to the current values</p>																				

Command	Description
@AACHN	Clear channel high latched analog input to the current value N = 0 for CO ₂ , 1 for relative humidity, 2 for temperature in 0.01°C, 3 for temperature in 0.01°F, 4 for dew point temperature in 0.01°C, 5 for dew point temperature in 0.01°F
@AACHCN	Clear high latched alarm of a channel, N = 0 for CO ₂ , 1 for relative humidity, 2 for temperature in 0.01°C, 3 for temperature in 0.01°F, 4 for dew point temperature in 0.01°C, 5 for dew point temperature in 0.01°F
@AACL	Clear all low latched analog inputs to the current values
@AACLN	Clear channel low latched analog input to the current value N = 0 for CO ₂ , 1 for relative humidity, 2 for temperature in 0.01°C, 3 for temperature in 0.01°F, 4 for dew point temperature in 0.01°C, 5 for dew point temperature in 0.01°F
@AACL CN	Clear low latched alarm of a channel, N = 1 for relative humidity, 2 for temperature in 0.01°C, 3 for temperature in 0.01°F, 4 for dew point temperature in 0.01°C, 5 for dew point temperature in 0.01°F
@AADACN	Disable AI alarm of a channel, N = 0 for CO ₂ , 1 for relative humidity, 2 for temperature in 0.01°C, 3 for temperature in 0.01°F, 4 for dew point temperature in 0.01°C, 5 for dew point temperature in 0.01°F

@AADI	read DO response !AA00000
@AADO0V	set DO, V-> 0: off, 1: on
@AAEATCN	Enable AI alarm of a channel, N = 0 for CO ₂ , 1 for relative humidity, 2 for temperature in 0.01°C, 3 for temperature in 0.01°F, 4 for dew point temperature in 0.01°C, 5 for dew point temperature in 0.01°F T = M for momentary alarm, L for latched alarm
@AAHI(data)CN	Set high alarm limit of an AI channel, N = 0 for CO ₂ in 1ppm, 1 for relative humidity in 0.01%, 2 for temperature in 0.01°C, 3 for temperature in 0.01°F, 4 for dew point temperature in 0.01°C, 5 for dew point temperature in 0.01°F
@AAHO	Read humidity offset
@AAHO(data)	Set humidity offset, data in format of -100.00 ~ +100.00
@AALO(data)CN	Set low alarm limit of an AI channel, N = 1 for relative humidity in 0.01%, 2 for temperature in 0.01°C, 3 for temperature in 0.01°F, 4 for dew point temperature in 0.01°C, 5 for dew point temperature in 0.01°F
@AARACN	Read AI alarm enabled/disabled status of a channel response !AAN, N->0: disabled, 1: momentary, 2: latched

Command	Description
@AARAO	Read AI alarm status response !AAHLL
@AARH	Read all high latched values of analog input channels response >(CO ₂ in 1 ppm)(relative humidity in 0.01%)(temperature in 0.01°C)(temperature in 0.01°F) (dew point temperature in 0.01°C)(dew point temperature in 0.01°F)
@AARHN	Read channel high latched value of analog input N = 0 for CO ₂ in 1 ppm, 1 for relative humidity in 0.01%, 2 for temperature in 0.01°C, 3 for temperature in 0.01°F, 4 for dew point temperature in 0.01°C, 5 for dew point temperature in 0.01°F
@AARHCN	Read high alarm limit of an AI channel N = 0 for CO ₂ in 1 ppm, 1 for relative humidity in 0.01%, 2 for temperature in 0.01°C, 3 for temperature in 0.01°F, 4 for dew point temperature in 0.01°C, 5 for dew point temperature in 0.01°F
@AARL	Read all low latched values of analog input channels response >(CO ₂ in 1 ppm)(relative humidity in 0.01%)(temperature in 0.01°C)(temperature in 0.01°F) (dew point temperature in 0.01°C)(dew point temperature in 0.01°F)
@AARLN	Read channel low latched value of analog input N = 0 for CO ₂ in 1 ppm, 1 for relative humidity in 0.01%, 2 for temperature in 0.01°C, 3 for temperature in 0.01°F, 4 for dew point temperature in 0.01°C, 5 for dew point temperature in 0.01°F
@AARLCN	Read low alarm limit of an AI channel N = 1 for relative humidity in 0.01%,

	2 for temperature in 0.01°C, 3 for temperature in 0.01°F, 4 for dew point temperature in 0.01°C, 5 for dew point temperature in 0.01°F
@AART	Read RTC data
@AARTYYMMD DHHMMSS	Set RTC data
@AASS	Read screen saver time
@AASSHHHH	Set screen saver time in seconds in hex format, 0000h to FFFFh, 0000 to disable
@AATO	Read temperature offset in 0.01°C
@AATO(data)	Set temperature offset in 0.01°C, -100.00 ~ +100.00
~**	clear host watchdog timeout counter
~AA0	read host watchdog status
~AA1	clear host watchdog timeout status
~AA2	read host watchdog enable/disable status and timeout value
~AA3ETT	enable/disable host watchdog and set timeout value E-> 0: disable host watchdog, 1: enable host watchdog TT: host watchdog timeout in 0.1s in hex format
~AA4	read DO power on and safe value
~AA50P0S	set DO power on and safe value P-> 0: power on value off, 1: power on value on S-> 0: safe value off, 1: safe value on
~AARD	read response delay time in ms in hex format
~AARDVV	set response delay time in ms, VV in hex format, 00 - 1E

A-3. DL-303 DCON Command Sets

Command	Description
\$AAF	reads firmware version
\$AAI	reads INIT status response: !AA0 -> INIT short to GND !AA1 -> else
\$AAM	reads module name
\$AAP	read Modbus RTU/DCON protocol response: !AA0 -> DCON !AA1 -> Modbus RTU
\$AAPN	sets Modbus RTU/DCON protocol N-> 0: DCON, 1: Modbus RTU
\$AA2	reads configuration
\$AA5	reads reset status !AA1 first after power on, !AA0 others
#AA	reads All Analog Inputs response >(CO in 1 ppm) (CO2 in 1 ppm) (relative humidity in 0.01%)(temperature in 0.01°C)(temperature in 0.01°F) (dew point temperature in 0.01°C)(dew point temperature in 0.01°F)
#AAN	reads Channel Analog Input N = 0 for CO in 1 ppm, 1 for CO2 in 1 ppm, 2 for relative humidity in 0.01%, 3 for temperature in 0.01°C, 4 for temperature in 0.01°F, 5 for dew point temperature in 0.01°C, 6 for dew point temperature in 0.01°F
%AANNTTCCFF	sets configuration, AA: current address, NN: new address, TT = 00,

	<p>CC: new baud rate</p> <p>Bits 5:0 : Baud rate, 0x03 ~ 0x0A</p> <table border="1"> <tr> <td>Code</td> <td>0x03</td> <td>0x04</td> <td>0x05</td> <td>0x06</td> </tr> <tr> <td>Baud</td> <td>1200</td> <td>2400</td> <td>4800</td> <td>9600</td> </tr> <tr> <td>Code</td> <td>0x07</td> <td>0x08</td> <td>0x09</td> <td>0x0A</td> </tr> <tr> <td>Baud</td> <td>19200</td> <td>38400</td> <td>57600</td> <td>115200</td> </tr> </table> <p>Bits 7:6</p> <p>00: no parity, 1 stop bit (N,8,1) 01: no parity, 2 stop bits (N,8,2) 10: even parity, 1 stop bit (E,8,1) 11: odd parity, 1 stop bit (O,8,1)</p> <p>FF: data format</p> <p>Bit 6</p> <p>0: checksum disabled 1: checksum enabled</p>	Code	0x03	0x04	0x05	0x06	Baud	1200	2400	4800	9600	Code	0x07	0x08	0x09	0x0A	Baud	19200	38400	57600	115200
Code	0x03	0x04	0x05	0x06																	
Baud	1200	2400	4800	9600																	
Code	0x07	0x08	0x09	0x0A																	
Baud	19200	38400	57600	115200																	
@AAABC	<p>reads status of the automatic baseline correction response</p> <p>!AAN, N=0: disabled, 1: enabled</p>																				
@AAABCN	<p>sets the automatic baseline correction</p> <p>N->0: disabled, 1: enabled</p>																				
@AABA	<p>reads beep on alarm time response</p> <p>!AAHH, HH in hex, 0: disabled, 1 ~ 250: beep on alarm time in seconds, 251: beep on alarm continuously</p>																				
@AABAHH	<p>sets beep on alarm</p> <p>HH in hex, 0: disabled, 1 ~ 250: beep on alarm time in seconds, 251: beep on alarm continuously</p>																				
@AABL	<p>reads LCD back light response</p> <p>!AAHH, HH: 00 ~ FF in hex</p>																				
@AABLHH	<p>sets LCD back light, HH: 00 ~ FF in hex</p>																				
@AACH	<p>clears all high latched analog inputs to the current values</p>																				

Command	Description
@AACHN	clears channel high latched analog input to the current value, N = 0 for CO, 1 for CO ₂ , 2 for relative humidity, 3 for temperature in 0.01°C, 4 for temperature in 0.01°F, 5 for dew point temperature in 0.01°C, 6 for dew point temperature in 0.01°F
@AACHCN	clears high latched alarm of a channel, N = 0 for CO, 1 for CO ₂ , 2 for relative humidity, 3 for temperature in 0.01°C, 4 for temperature in 0.01°F, 5 for dew point temperature in 0.01°C, 6 for dew point temperature in 0.01°F
@AACL	clears all low latched analog inputs to the current values
@AACLN	clears channel low latched analog input to the current value, N = 0 for CO, 1 for CO ₂ , 2 for relative humidity, 3 for temperature in 0.01°C, 4 for temperature in 0.01°F, 5 for dew point temperature in 0.01°C, 6 for dew point temperature in 0.01°F
@AACLNCN	clears low latched alarm of a channel, N = 2 for relative humidity, 3 for temperature in 0.01°C, 4 for temperature in 0.01°F, 5 for dew point temperature in 0.01°C, 6 for dew point temperature in 0.01°F
@AADACN	disables AI alarm of a channel, N = 0 for CO, 1 for CO ₂ , 2 for relative humidity, 3 for temperature in 0.01°C, 4 for temperature in 0.01°F,

	5 for dew point temperature in 0.01°C, 6 for dew point temperature in 0.01°F
@AADI	reads DO response !AA00000
@AADO0V	sets DO, V-> 0: off, 1: on
@AAEATCN	enables AI alarm of a channel, N = 0 for CO, 1 for CO ₂ , 2 for relative humidity, 3 for temperature in 0.01°C, 4 for temperature in 0.01°F, 5 for dew point temperature in 0.01°C, 6 for dew point temperature in 0.01°F T->M: momentary alarm, L: latched alarm
@AAHI(data)CN	sets high alarm limit of an AI channel, N = 0 for CO in 1ppm, 1 for CO ₂ in 1ppm, 2 for relative humidity in 0.01%, 3 for temperature in 0.01°C, 4 for temperature in 0.01°F, 5 for dew point temperature in 0.01°C, 6 for dew point temperature in 0.01°F
@AAHO	reads humidity offset
@AAHO(data)	sets humidity offset, data in format of -100.00 ~ +100.00
@AALO(data)CN	sets low alarm limit of an AI channel, N = 2 for relative humidity in 0.01%, 3 for temperature in 0.01°C, 4 for temperature in 0.01°F, 5 for dew point temperature in 0.01°C, 6 for dew point temperature in 0.01°F
@AARACN	reads AI alarm enabled/disabled status of a channel response !AAN, N->0: disabled, 1: momentary, 2: latched

Command	Description
@AARAO	reads AI alarm status response !AAHLL
@AARH	reads all high latched values of analog input channels response >(CO in 1 ppm) (CO2 in 1 ppm) (relative humidity in 0.01%)(temperature in 0.01°C)(temperature in 0.01°F) (dew point temperature in 0.01°C)(dew point temperature in 0.01°F)
@AARHN	reads channel high latched value of analog input N = 0 for CO in 1 ppm, 1 for CO2 in 1 ppm, 2 for relative humidity in 0.01%, 3 for temperature in 0.01°C, 4 for temperature in 0.01°F, 5 for dew point temperature in 0.01°C, 6 for dew point temperature in 0.01°F
@AARHCN	reads high alarm limit of an AI channel N = 0 for CO in 1 ppm, 1 for CO2 in 1 ppm, 2 for relative humidity in 0.01%, 3 for temperature in 0.01°C, 4 for temperature in 0.01°F, 5 for dew point temperature in 0.01°C, 6 for dew point temperature in 0.01°F
@AARL	reads all low latched values of analog input channels response >(CO in 1 ppm) (CO2 in 1 ppm) (relative humidity in 0.01%)(temperature in 0.01°C)(temperature in 0.01°F) (dew point temperature in 0.01°C)(dew point temperature in 0.01°F)
@AARLN	reads channel low latched value of analog input N = 0 for CO in 1 ppm, 1 for CO2 in 1 ppm, 2 for relative humidity in 0.01%, 3 for temperature in 0.01°C, 4 for temperature in 0.01°F, 5 for dew point temperature in 0.01°C, 6 for dew point temperature in 0.01°F

@AARLCN	reads low alarm limit of an AI channel N = 2 for relative humidity in 0.01%, 3 for temperature in 0.01°C, 4 for temperature in 0.01°F, 5 for dew point temperature in 0.01°C, 6 for dew point temperature in 0.01°F
@AART	reads RTC data
@AARTYYMMD DHHMMSS	sets RTC data
@AASS	reads screen saver time
@AASSHHHH	sets screen saver time in seconds in hex format, 0000h to FFFFh, 0000 to disable
@AATO	reads temperature offset in 0.01°C
@AATO(data)	sets temperature offset in 0.01°C, -100.00 ~ +100.00
~**	clears host watchdog timeout counter
~AA0	reads host watchdog status
~AA1	clears host watchdog timeout status
~AA2	reads host watchdog enable/disable status and timeout value
~AA3ETT	enables/disables host watchdog and set timeout value E-> 0: disable host watchdog, 1: enable host watchdog TT: host watchdog timeout in 0.1s in hex format
~AA4	reads DO power on and safe value
~AA50POS	sets DO power on and safe value P-> 0: power on value off, 1: power on value on S-> 0: safe value off, 1: safe value on
~AARD	reads response delay time in ms in hex format
~AARDVV	sets response delay time in ms, VV in hex format, 00 - 1E

Appendix B: ModbusMasterToolPC

ModbusMasterToolPC is a free, easy-to-use tool for Modbus communication and diagnosing the wiring. It is located in the company CD:

CD:\Napdos\DL-300\utility\ and needless to install

This section intends to guide the steps for creating the Modbus communication with DL-300 logger.

1. Launch the ModbusMasterToolPC.exe.
2. Select **New** in the File menu.

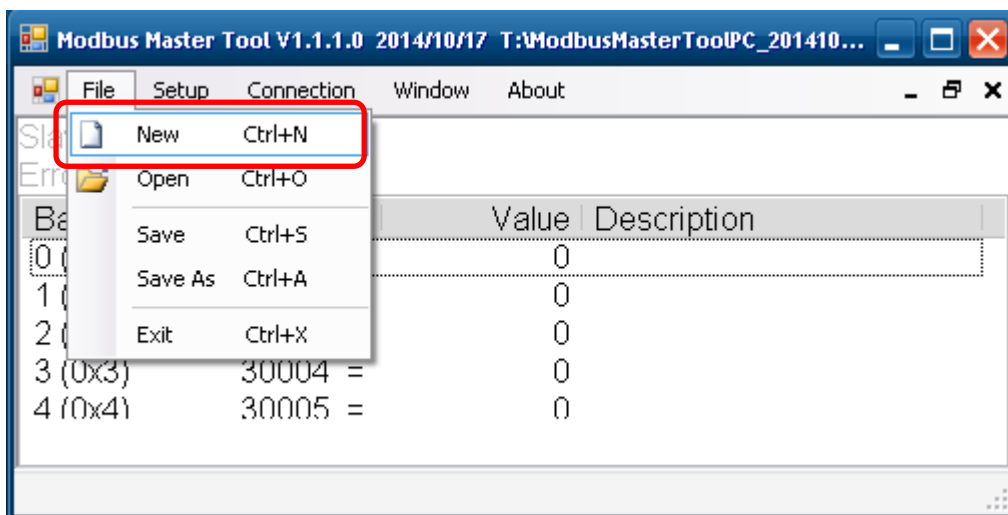

3. Input the file name and click on the **Save** button.

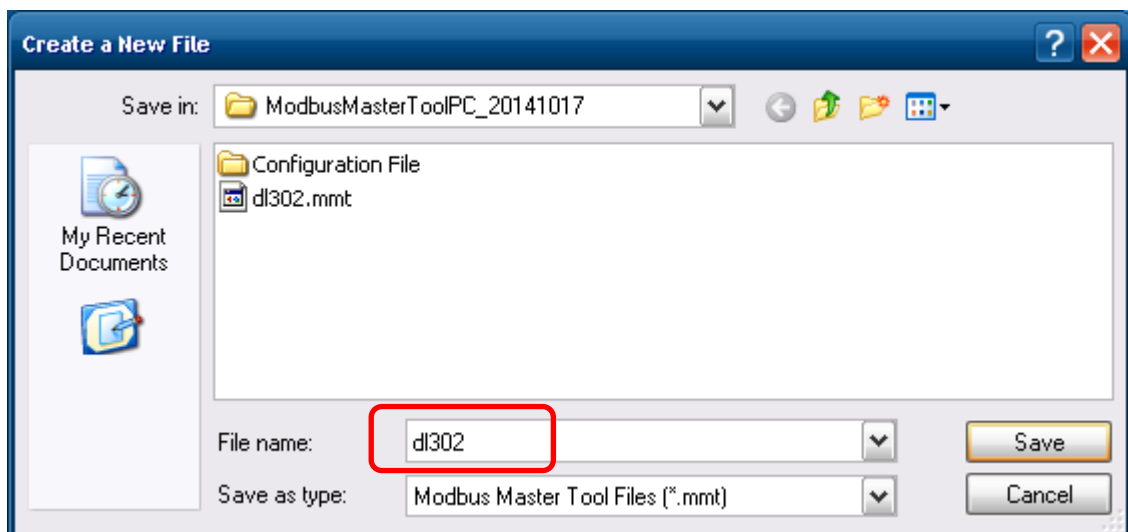

4. Select **Connect** in the *Connection* menu.

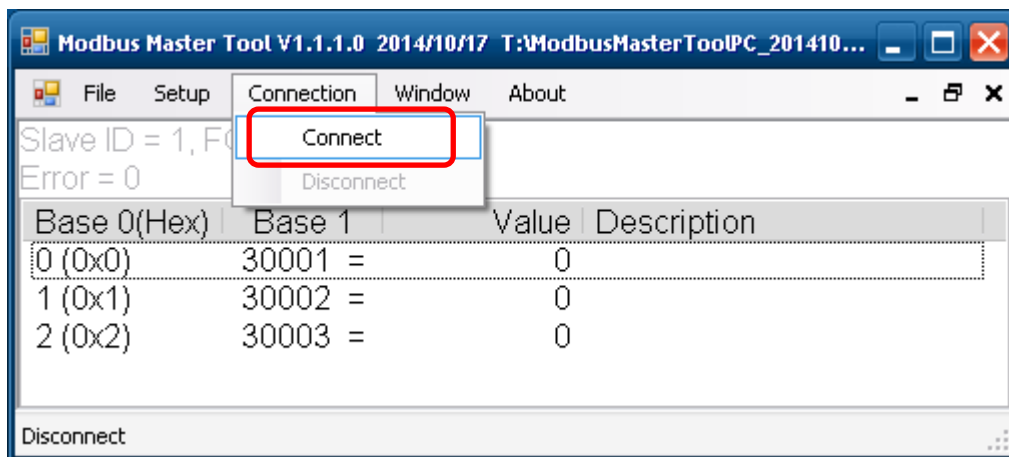

5. Select the communication interface. When using **TCP/IP** as the interface, input the IP for your logger and click on the **OK** button.

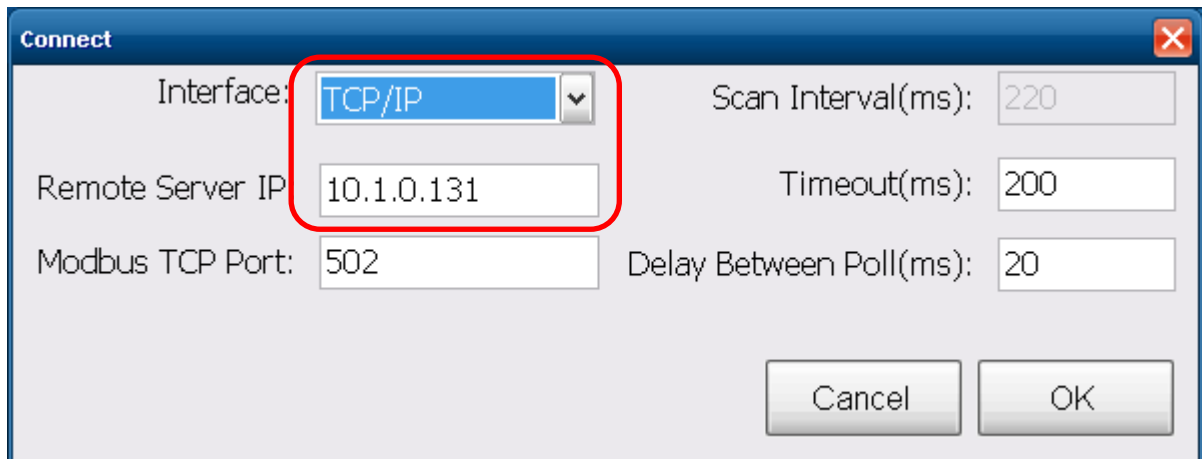

When using RS-485 as the interface, select the COM port, check the RTU mode and click on the **OK** button.

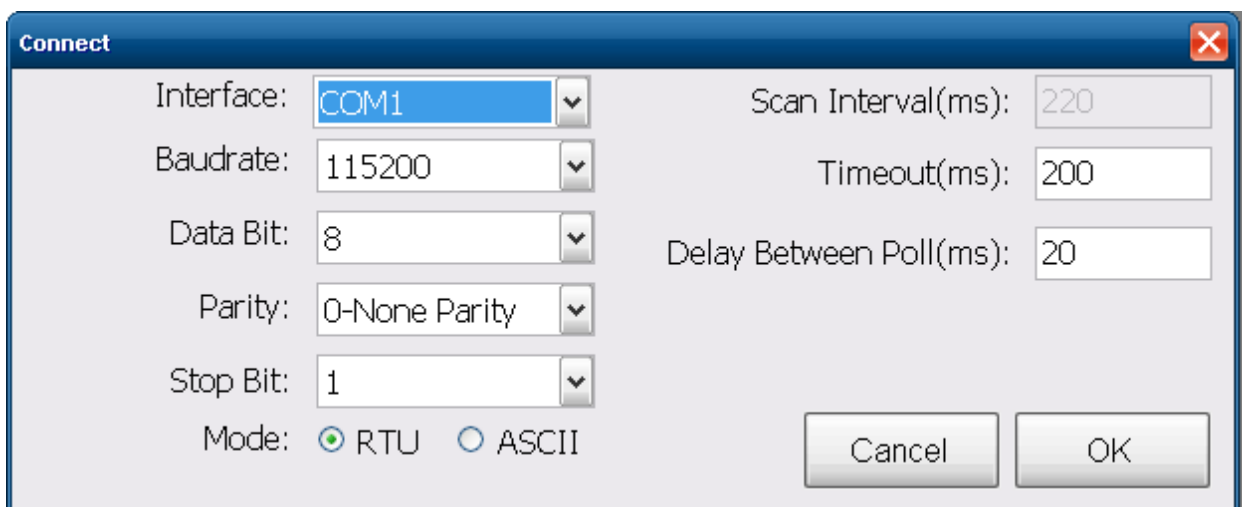

6. Select **Definition** in the **Setup** menu.

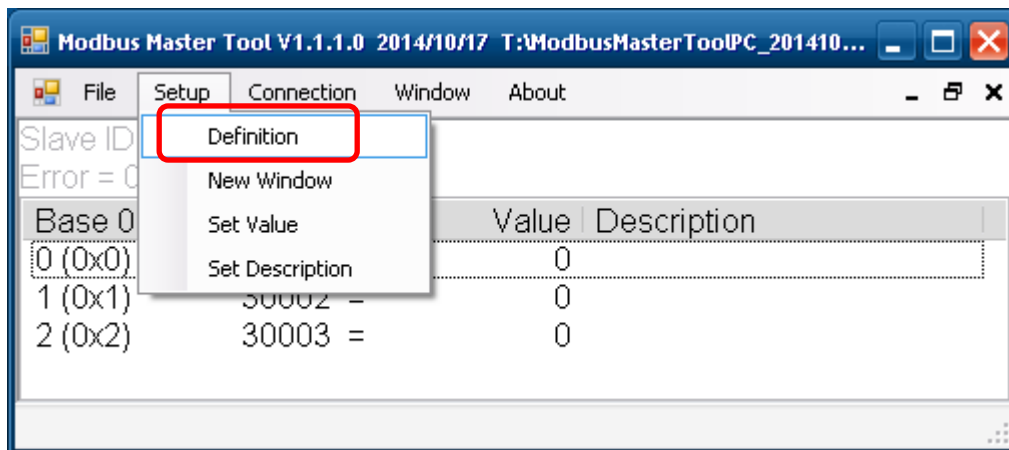

7. Select the Modbus function code, input the start address and length, and click on the **OK** button.

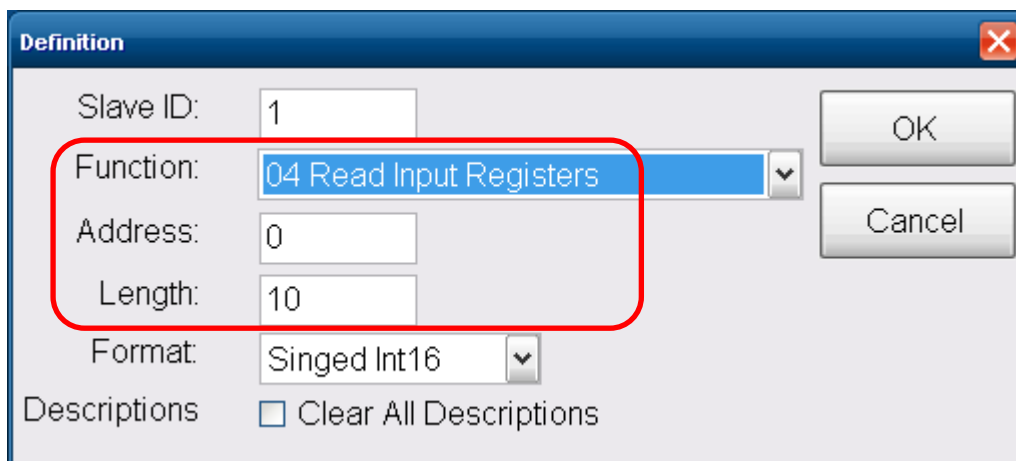

8. Read data.

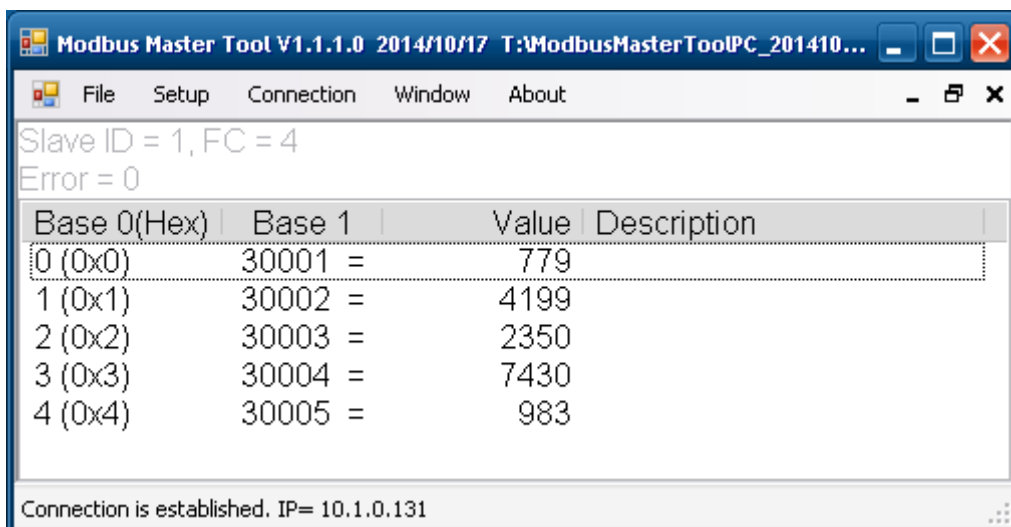

9. Write data to Holding Register or Coil Status

1. Highlight the Modbus address in the Holding Register or Coil Status list
2. Select **Set Value** in the *Setup* menu.
3. Input the data in the Value box and click on the **OK** button

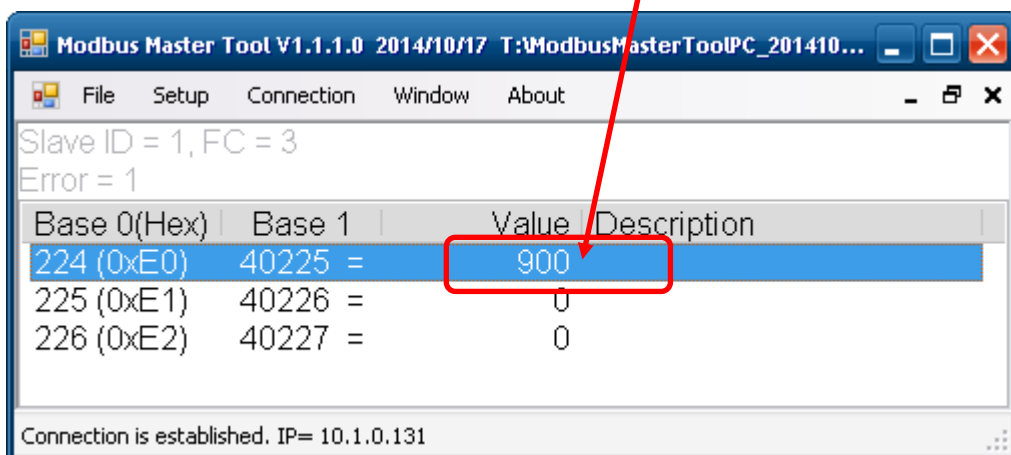
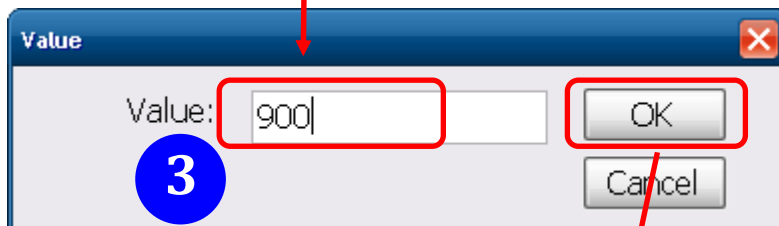
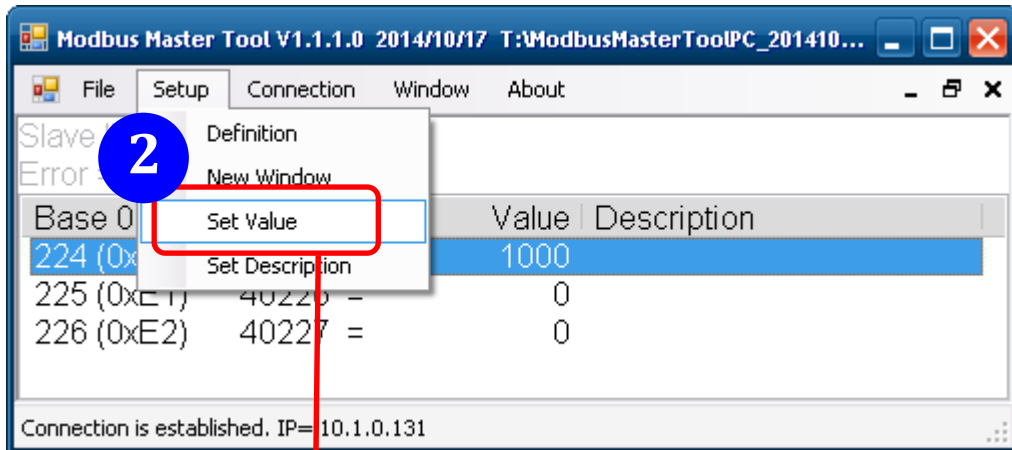

Appendix C: Modbus Address Table

C-1. DL-301 Modbus Address Mappings (Base 1)

Address	Description	Attribute
30001 ~ 30006 40001 ~ 40006	Analog input value of channel 0 to 5. channel 0: CO in 1ppm, channel 1: relative humidity in 0.01%, channel 2: temperature in 0.01°C, channel 3:temperature in 0.01°F, channel 4: dew point temperature in 0.01°C, channel 5: dew point temperature in 0.01°F	R
40225 ~ 40230	High alarm limit of channel 0 to 5, channel 0: CO in 1ppm, channel 1: relative humidity in 0.01%, channel 2: temperature in 0.01°C, channel 3:temperature in 0.01°F, channel 4: dew point temperature in 0.01°C, channel 5: dew point temperature in 0.01°F	R/W
40234 ~ 40238	Low alarm limit of channel 1 to 5, channel 1: relative humidity in 0.01%, channel 2: temperature in 0.01°C, channel 3:temperature in 0.01°F, channel 4: dew point temperature in 0.01°C, channel 5: dew point temperature in 0.01°F	R/W
40272	Modbus NetID Only for Modbus TCP protocol	R/W
30301 40301	Number of the digital input channels Only for Modbus TCP protocol	R
30311 40311	Number of the digital output channels Only for Modbus TCP protocol	R
30321 40321	Number of the analog input channels Only for Modbus TCP protocol	R

Address	Description	Attribute																				
30331	Number of the analog output channels	R																				
40331	Only for Modbus TCP protocol																					
30352	Firmware version in hex format	R																				
40352	Only for Modbus TCP protocol																					
40450	Relative humidity offset in 0.01%	R/W																				
40451	Temperature offset in 0.01°C	R/W																				
40481	Firmware version (low word)	R																				
40482	Firmware version (high word)	R																				
40483	Module name (low word), 0x0301	R																				
40484	Module name (high word), 0x444C	R																				
40485	RS-485 module address, 1 to 247 Only for Modbus RTU protocol	R/W																				
40486	RS-485 baud rate and parity settings Bits 5:0 Baud rate, valid range: 3 ~ 10 <table border="1" data-bbox="411 969 1102 1223"> <tbody> <tr> <td>Code</td> <td>0x03</td> <td>0x04</td> <td>0x05</td> <td>0x06</td> </tr> <tr> <td>Baud</td> <td>1200</td> <td>2400</td> <td>4800</td> <td>9600</td> </tr> <tr> <td>Code</td> <td>0x07</td> <td>0x08</td> <td>0x09</td> <td>0x0A</td> </tr> <tr> <td>Baud</td> <td>19200</td> <td>38400</td> <td>57600</td> <td>115200</td> </tr> </tbody> </table> Bits 7:6 00: no parity, 1 stop bit (N,8,1) 01: no parity, 2 stop bits (N,8,2) 10: even parity, 1 stop bit (E,8,1) 11: odd parity, 1 stop bit (O,8,1) Only for Modbus RTU protocol	Code	0x03	0x04	0x05	0x06	Baud	1200	2400	4800	9600	Code	0x07	0x08	0x09	0x0A	Baud	19200	38400	57600	115200	R/W
Code	0x03	0x04	0x05	0x06																		
Baud	1200	2400	4800	9600																		
Code	0x07	0x08	0x09	0x0A																		
Baud	19200	38400	57600	115200																		
40488	RS-485 response delay time in ms, valid range, 0 ~ 30 Only for Modbus RTU protocol	R/W																				
40489	RS-485 host watchdog timeout value, 0 ~ 255, in 0.1s Only for Modbus RTU protocol	R/W																				
40492	RS-485 host watchdog timeout count, write 0 to clear Only for Modbus RTU protocol	R/W																				
40495	LCD back light setting, 0 to 255	R/W																				

Address	Description	Attribute
40497	Beep on alarm, 0: disable, 1 to 250: beep on alarm time in seconds, 251: beep on alarm continuously	R/W
40498	Screen saver time in seconds, 0 to 65535, 0: disable	R/W
30513 ~ 30518 40513 ~ 40518	High latched analog input value of channel 0 to 5 channel 0: CO in 1ppm, channel 1: relative humidity in 0.01%, channel 2: temperature in 0.01°C, channel 3:temperature in 0.01°F, channel 4: dew point temperature in 0.01°C, channel 5: dew point temperature in 0.01°F	R
30545 ~ 30550 40545 ~ 40550	Low latched analog input value of channel 0 to 5 channel 0: CO in 1ppm, channel 1: relative humidity in 0.01%, channel 2: temperature in 0.01°C, channel 3:temperature in 0.01°F, channel 4: dew point temperature in 0.01°C, channel 5: dew point temperature in 0.01°F	R
30556 40556	Module reset status, 1: power-on, 2: watchdog, 3: software reset command Only for Modbus TCP protocol	R
40558	Ethernet host watchdog timeout value, 5 to 65535, in second, 0 to disable. Only for Modbus TCP protocol	R/W
30559 40559	Ethernet host watchdog timeout count. Only for Modbus TCP protocol	R
30560 40560	Module name, 0x0301 Only for Modbus TCP protocol	R
40564	TCP disconnection timeout value, 5 to 65535, in second, 0 to disable. Only for Modbus TCP protocol	R/W
40565	Module reset timeout value, 30 to 65535, in second, 0 to disable. Only for Modbus TCP protocol	R/W

40859	The time for displaying message, ranged from 1 to 65535 in seconds. 0 to display a message until a stop command received	R/W
40861	The index for a pre-saved message to display on the LCD screen, 0 ~ 19, -1(65535) to stop	R/W
40865	RTC year, 2000 to 2159	R/W
40866	RTC month, 1 to 12	R/W

Address	Description	Attribute
40867	RTC date, 1 to 31	R/W
40868	RTC hour, 0 to 23	R/W
40869	RTC minute, 0 to 59	R/W
40870	RTC second, 0 to 59	R/W
40871	Total number of log records, low word	R
40872	Total number of log records, high word	R
40873	The starting record to read log data, low word	R/W
40874	The starting record to read log data, high word	R/W
40875	The status of the data logging, 0: stopped, 1: running	R
40876	The data logger command, 0: stop, 1: run, 2: run in period mode	R/W
40877	Continue writing when data logger is full, 0: no, 1: yes	R/W
40878	Hour of the data logger sampling period, 0 ~ 24	R/W
40879	Minute of the data logger sampling period, 0 ~ 59	R/W
40880	Second of the data logger sampling period, 0 ~ 59	R/W
40881	Starting year when logging in period mode, 2000 ~ 2159	R/W
40882	Starting month when logging in period mode, 1 ~ 12	R/W
40883	Starting date when logging in period mode, 1 ~ 31	R/W
40884	Starting hour when logging in period mode, 0 ~ 23	R/W
40885	Starting minute when logging in period mode, 0 ~ 59	R/W
40886	Starting second when logging in period mode, 0 ~ 59	R/W

Address	Description	Attribute
40887	Ending year when logging in period mode, 2000 ~ 2159	R/W
40888	Ending month when logging in period mode, 1 ~ 12	R/W
40889	Ending date when logging in period mode, 1 ~ 31	R/W
40890	Ending hour when logging in period mode, 0 ~ 23	R/W
40891	Ending minute when logging in period mode, 0 ~ 59	R/W
40892	Ending second when logging in period mode, 0 ~ 59	R/W
450302	Saves or shows message, by Modbus function 16 only. Refer to Q12 in section FAQ (page 75) for more information.	W
00001	Digital output value of channel 0	R/W
00129	Safe value of digital output channel 0	R/W
00161	Power on value of digital output channel 0	R/W
00227	Write 1 to reload default TCP settings Only for Modbus TCP protocol	W
00234	Write 1 to reboot module Only for Modbus TCP protocol	W
00257	RS-485 Protocol, 0: DCON, 1: Modbus RTU Only for Modbus RTU protocol	R/W

Address	Description	Attribute
00260	Modbus RTU host watchdog mode 0: same as I-7000 1: can use AO and DO command to clear host watchdog timeout status Only for Modbus RTU protocol	R/W
00261	RS-485 host watchdog mode, 1: enable, 0: disable. Only for Modbus RTU protocol	R/W
00262	Write 1 to play notification sound	W
00270	Host watch dog timeout status, write 1 to clear host watch dog timeout status Only for Modbus RTU protocol	R/W
00273	Reset status, 1: first read after powered on, 0: not the first read after powered on	R
00280	Write 1 to clear all high latched analog input values	W
00281	Write 1 to clear all low latched analog input values	W
00290 ~	Low alarm status of channel 1 to 5. Write 1 to clear low latched	R/W

00294	alarm. channel 1: relative humidity, channel 2: temperature in 0.01°C, channel 3:temperature in 0.01°F, channel 4: dew point temperature in 0.01°C, channel 5: dew point temperature in 0.01°F	
00305 ~ 00310	High alarm status of channel 0 to 5. Write 1 to clear high latched alarm. channel 0: CO, channel 1: relative humidity, channel 2: temperature in 0.01°C, channel 3:temperature in 0.01°F, channel 4: dew point temperature in 0.01°C, channel 5: dew point temperature in 0.01°F	R/W
00321 ~ 00326	Enable/disable alarm of channel 0 to 5, write 0 to disable alarm ; write 1 to enable alarm. channel 0: CO, channel 1: relative humidity, channel 2: temperature in 0.01°C, channel 3:temperature in 0.01°F, channel 4: dew point temperature in 0.01°C, channel 5: dew point temperature in 0.01°F	R/W
00337 ~ 00342	Alarm type, momentary or latched, of channel 0 to 5, write 0 to enable momentary alarm mode; write 1 to enable latched alarm mode. channel 0: CO, channel 1: relative humidity in, channel 2: temperature in 0.01°C, channel 3:temperature in 0.01°F, channel 4: dew point temperature in 0.01°C, channel 5: dew point temperature in 0.01°F	R/W
00385 ~ 00390	Write 1 to clear high latched analog input value of channel 0 to 5, channel 0: CO channel 1: relative humidity, channel 2: temperature in 0.01°C, channel 3:temperature in 0.01°F, channel 4: dew point temperature in 0.01°C, channel 5: dew point temperature in 0.01°F	W

00417 ~ 00422	Write 1 to clear low latched analog input value of channel 0 to 5 channel 0: CO, channel 1: relative humidity, channel 2: temperature in 0.01°C, channel 3: temperature in 0.01°F, channel 4: dew point temperature in 0.01°C, channel 5: dew point temperature in 0.01°F	W
------------------	---	---

C-2. DL-302 Modbus Address Mappings (Base 1)

Address	Description	Attribute
30001 ~ 30006 40001 ~ 40006	Analog input value of channel 0 to 5. channel 0: CO ₂ in 1ppm, channel 1: relative humidity in 0.01%, channel 2: temperature in 0.01°C, channel 3:temperature in 0.01°F, channel 4: dew point temperature in 0.01°C, channel 5: dew point temperature in 0.01°F	R
40225 ~ 40230	High alarm limit of channel 0 to 5, channel 0: CO ₂ in 1ppm, channel 1: relative humidity in 0.01%, channel 2: temperature in 0.01°C, channel 3:temperature in 0.01°F, channel 4: dew point temperature in 0.01°C, channel 5: dew point temperature in 0.01°F	R/W
40234 ~ 40238	Low alarm limit of channel 1 to 5, channel 1: relative humidity in 0.01%, channel 2: temperature in 0.01°C, channel 3:temperature in 0.01°F, channel 4: dew point temperature in 0.01°C, channel 5: dew point temperature in 0.01°F	R/W
40272	Modbus NetID Only for Modbus TCP protocol	R/W
30301 40301	Number of the digital input channels Only for Modbus TCP protocol	R
30311 40311	Number of the digital output channels Only for Modbus TCP protocol	R
30321 40321	Number of the analog input channels Only for Modbus TCP protocol	R

Address	Description	Attribute																				
30331	Number of the analog output channels	R																				
40331	Only for Modbus TCP protocol																					
30352	Firmware version in hex format	R																				
40352	Only for Modbus TCP protocol																					
40450	Relative humidity offset in 0.01%	R/W																				
40451	Temperature offset in 0.01°C	R/W																				
40481	Firmware version (low word)	R																				
40482	Firmware version (high word)	R																				
40483	Module name (low word), 0x0302	R																				
40484	Module name (high word), 0x444C	R																				
40485	RS-485 module address, 1 to 247 Only for Modbus RTU protocol	R/W																				
40486	RS-485 baud rate and parity settings Bits 5:0 Baud rate, valid range: 3 ~ 10 <table border="1" data-bbox="391 981 1085 1236"> <tbody> <tr> <td>Code</td> <td>0x03</td> <td>0x04</td> <td>0x05</td> <td>0x06</td> </tr> <tr> <td>Baud</td> <td>1200</td> <td>2400</td> <td>4800</td> <td>9600</td> </tr> <tr> <td>Code</td> <td>0x07</td> <td>0x08</td> <td>0x09</td> <td>0x0A</td> </tr> <tr> <td>Baud</td> <td>19200</td> <td>38400</td> <td>57600</td> <td>115200</td> </tr> </tbody> </table> Bits 7:6 00: no parity, 1 stop bit (N,8,1) 01: no parity, 2 stop bit (N,8,2) 10: even parity, 1 stop bit (E,8,1) 11: odd parity , 1 stop bit (O,8,1) Only for Modbus RTU protocol	Code	0x03	0x04	0x05	0x06	Baud	1200	2400	4800	9600	Code	0x07	0x08	0x09	0x0A	Baud	19200	38400	57600	115200	R/W
Code	0x03	0x04	0x05	0x06																		
Baud	1200	2400	4800	9600																		
Code	0x07	0x08	0x09	0x0A																		
Baud	19200	38400	57600	115200																		
40488	RS-485 response delay time in ms, valid range, 0 ~ 30 Only for Modbus RTU protocol	R/W																				
40489	RS-485 host watchdog timeout value, 0 ~ 255, in 0.1s Only for Modbus RTU protocol	R/W																				
40492	RS-485 host watchdog timeout count, write 0 to clear Only for Modbus RTU protocol	R/W																				
40495	LCD back light setting, 0 to 255	R/W																				
40496	Automatic baseline correction for CO ₂ measurement. 0: disable, 1:enable	R/W																				

Address	Description	Attribute
40497	Beep on alarm, 0: disable, 1 to 250: beep on alarm time in seconds, 251: beep on alarm continuously	R/W
40498	Screen saver time in seconds, 0 to 65535, 0: disable	R/W
30513 ~ 30518 40513 ~ 40518	High latched analog input value of channel 0 to 5 channel 0: CO ₂ in 1ppm, channel 1: relative humidity in 0.01%, channel 2: temperature in 0.01°C, channel 3:temperature in 0.01°F, channel 4: dew point temperature in 0.01°C, channel 5: dew point temperature in 0.01°F	R
30545 ~ 30550 40545 ~ 40550	Low latched analog input value of channel 0 to 5 channel 0: CO ₂ in 1ppm, channel 1: relative humidity in 0.01%, channel 2: temperature in 0.01°C, channel 3:temperature in 0.01°F, channel 4: dew point temperature in 0.01°C, channel 5: dew point temperature in 0.01°F	R
30556 40556	Module reset status, 1: power-on, 2: watchdog, 3: software reset command Only for Modbus TCP protocol	R
40558	Ethernet host watchdog timeout value, 5 to 65535, in second, 0 to disable. Only for Modbus TCP protocol	R/W
30559 40559	Ethernet host watchdog timeout count. Only for Modbus TCP protocol	R
30560 40560	Module name, 0x0302 Only for Modbus TCP protocol	R
40564	TCP disconnection timeout value, 5 to 65535, in second, 0 to disable. Only for Modbus TCP protocol	R/W
40565	Module reset timeout value, 30 to 65535, in second, 0 to disable. Only for Modbus TCP protocol	R/W

40859	The time for displaying message, ranged from 1 to 65535 in seconds. 0 to display a message until a stop command received	R/W
40861	The index for a pre-saved message to display on the LCD screen, 0 ~ 19, -1(65535) to stop	R/W
40865	RTC year, 2000 to 2159	R/W
40866	RTC month, 1 to 12	R/W

Address	Description	Attribute
40867	RTC date, 1 to 31	R/W
40868	RTC hour, 0 to 23	R/W
40869	RTC minute, 0 to 59	R/W
40870	RTC second, 0 to 59	R/W
40871	Total number of log records, low word	R
40872	Total number of log records, high word	R
40873	The starting record to read log data, low word	R/W
40874	The starting record to read log data, high word	R/W
40875	The status of the data logging, 0: stopped, 1: running	R
40876	The data logger command, 0: stop, 1: run, 2: run in period mode	R/W
40877	Continue writing when data logger is full, 0: no, 1: yes	R/W
40878	Hour of the data logger sampling period, 0 ~ 24	R/W
40879	Minute of the data logger sampling period, 0 ~ 59	R/W
40880	Second of the data logger sampling period, 0 ~ 59	R/W
40881	Starting year when logging in period mode, 2000 ~ 2159	R/W
40882	Starting month when logging in period mode, 1 ~ 12	R/W
40883	Starting date when logging in period mode, 1 ~ 31	R/W
40884	Starting hour when logging in period mode, 0 ~ 23	R/W
40885	Starting minute when logging in period mode, 0 ~ 59	R/W
40886	Starting second when logging in period mode, 0 ~ 59	R/W

Address	Description	Attribute
40887	Ending year when logging in period mode, 2000 ~ 2159	R/W
40888	Ending month when logging in period mode, 1 ~ 12	R/W
40889	Ending date when logging in period mode, 1 ~ 31	R/W
40890	Ending hour when logging in period mode, 0 ~ 23	R/W
40891	Ending minute when logging in period mode, 0 ~ 59	R/W
40892	Ending second when logging in period mode, 0 ~ 59	R/W
450302	Saves or shows message, by Modbus function 16 only. Refer to Q12 in section FAQ (page 75) for more information.	W
00001	Digital output value of channel 0	R/W
00129	Safe value of digital output channel 0	R/W
00161	Power on value of digital output channel 0	R/W
00227	Write 1 to reload default TCP settings Only for Modbus TCP protocol	W
00234	Write 1 to reboot module Only for Modbus TCP protocol	W
00257	RS-485 Protocol, 0: DCON, 1: Modbus RTU Only for Modbus RTU protocol	R/W

Address	Description	Attribute
00260	Modbus RTU host watchdog mode 0: same as I-7000 1: can use AO and DO command to clear host watchdog timeout status Only for Modbus RTU protocol	R/W
00261	RS-485 host watchdog mode, 1: enabled, 0: disabled. Only for Modbus RTU protocol	R/W
00262	Write 1 to play notification sound	W
00270	Host watch dog timeout status, write 1 to clear host watch dog timeout status Only for Modbus RTU protocol	R/W
00273	Reset status, 1: first read after powered on, 0: not the first read after powered on	R
00280	Write 1 to clear all high latched analog input values	W
00281	Write 1 to clear all low latched analog input values	W
00290 ~	Low alarm status of channel 1 to 5. Write 1 to clear low latched	R/W

00294	alarm. channel 1: relative humidity channel 2: temperature in 0.01°C, channel 3:temperature in 0.01°F, channel 4: dew point temperature in 0.01°C, channel 5: dew point temperature in 0.01°F	
00305 ~ 00310	High alarm status of channel 0 to 5. Write 1 to clear high latched alarm. channel 0: CO ₂ channel 1: relative humidity channel 2: temperature in 0.01°C, channel 3:temperature in 0.01°F, channel 4: dew point temperature in 0.01°C, channel 5: dew point temperature in 0.01°F	R/W
00321 ~ 00326	Enable/disable alarm of channel 0 to 5; write 0 to disable alarm or write 1 to enable alarm. channel 0: CO ₂ channel 1: relative humidity channel 2: temperature in 0.01°C, channel 3:temperature in 0.01°F, channel 4: dew point temperature in 0.01°C, channel 5: dew point temperature in 0.01°F	R/W
00337 ~ 00342	Alarm mode, momentary or latched, of channel 0 to 5; write 0 to enable momentary alarm mode or write 1 to enable latched alarm mode. channel 0: CO ₂ channel 1: relative humidity channel 2: temperature in 0.01°C, channel 3:temperature in 0.01°F, channel 4: dew point temperature in 0.01°C, channel 5: dew point temperature in 0.01°F	R/W
00385 ~ 00390	Write 1 to clear high latched analog input value of channel 0 to 5	W
00417 ~ 00422	Write 1 to clear low latched analog input value of channel 0 to 5	W

C-3. DL-303 Modbus Address Mappings (Base 1)

Address	Description	Attribute
30001 ~ 30007 40001 ~ 40007	Analog input value of channel 0 to 6. channel 0: CO in 1ppm, channel 1: CO ₂ in 1ppm, channel 2: relative humidity in 0.01%, channel 3: temperature in 0.01°C, channel 4:temperature in 0.01°F, channel 5: dew point temperature in 0.01°C, channel 6: dew point temperature in 0.01°F	R
40225 ~ 40231	High alarm limit of channel 0 to 6, channel 0: CO in 1ppm, channel 1: CO ₂ in 1ppm, channel 2: relative humidity in 0.01%, channel 3: temperature in 0.01°C, channel 4:temperature in 0.01°F, channel 5: dew point temperature in 0.01°C, channel 6: dew point temperature in 0.01°F	R/W
40234 ~ 40239	Low alarm limit of channel 2 to 6, channel 2: relative humidity in 0.01%, channel 3: temperature in 0.01°C, channel 4:temperature in 0.01°F, channel 5: dew point temperature in 0.01°C, channel 6: dew point temperature in 0.01°F	R/W
40272	Modbus NetID Only for Modbus TCP protocol	R/W
30301 40301	Number of the digital input channels Only for Modbus TCP protocol	R
30311 40311	Number of the digital output channels Only for Modbus TCP protocol	R

Address	Description	Attribute																				
30321	Number of the analog input channels																					
40321	Only for Modbus TCP protocol																					
30331	Number of the analog output channels	R																				
40331	Only for Modbus TCP protocol																					
30352	Firmware version in hex format	R																				
40352	Only for Modbus TCP protocol																					
40450	Relative humidity offset in 0.01%	R/W																				
40451	Temperature offset in 0.01°C	R/W																				
40481	Firmware version (low word)	R																				
40482	Firmware version (high word)	R																				
40483	Module name (low word), 0x0303	R																				
40484	Module name (high word), 0x444C	R																				
40485	RS-485 module address, 1 to 247 Only for Modbus RTU protocol	R/W																				
40486	RS-485 baud rate and parity settings Bits 5:0 Baud rate, valid range: 3 ~ 10 <table border="1" style="margin-left: 40px;"> <tbody> <tr> <td>Code</td> <td>0x03</td> <td>0x04</td> <td>0x05</td> <td>0x06</td> </tr> <tr> <td>Baud</td> <td>1200</td> <td>2400</td> <td>4800</td> <td>9600</td> </tr> <tr> <td>Code</td> <td>0x07</td> <td>0x08</td> <td>0x09</td> <td>0x0A</td> </tr> <tr> <td>Baud</td> <td>19200</td> <td>38400</td> <td>57600</td> <td>115200</td> </tr> </tbody> </table> Bits 7:6 00: no parity, 1 stop bit (N,8,1) 01: no parity, 2 stop bit (N,8,2) 10: even parity, 1 stop bit (E,8,1) 11: odd parity , 1 stop bit (O,8,1) Only for Modbus RTU protocol	Code	0x03	0x04	0x05	0x06	Baud	1200	2400	4800	9600	Code	0x07	0x08	0x09	0x0A	Baud	19200	38400	57600	115200	R/W
Code	0x03	0x04	0x05	0x06																		
Baud	1200	2400	4800	9600																		
Code	0x07	0x08	0x09	0x0A																		
Baud	19200	38400	57600	115200																		
40488	RS-485 response delay time in ms, valid range, 0 ~ 30 Only for Modbus RTU protocol	R/W																				
40489	RS-485 host watchdog timeout value, 0 ~ 255, in 0.1s Only for Modbus RTU protocol	R/W																				
40492	RS-485 host watchdog timeout count, write 0 to clear Only for Modbus RTU protocol	R/W																				
40495	LCD back light setting, 0 to 255	R/W																				
40496	Automatic baseline correction for CO ₂ measurement, 0: disable, 1:enable	R/W																				

Address	Description	Attribute
40497	Beep on alarm, 0: disable, 1 to 250: beep on alarm time in seconds, 251: beep on alarm continuously	R/W
40498	Screen saver time in seconds, 0 to 65535, 0: disable	R/W
30513 ~ 30519 40513 ~ 40519	High latched analog input value of channel 0 to 6 channel 0: CO in 1ppm, channel 1: CO ₂ in 1ppm, channel 2: relative humidity in 0.01%, channel 3: temperature in 0.01°C, channel 4:temperature in 0.01°F, channel 5: dew point temperature in 0.01°C, channel 6: dew point temperature in 0.01°F	R
30545 ~ 30551 40545 ~ 40551	Low latched analog input value of channel 0 to 6 channel 0: CO in 1ppm, channel 1: CO ₂ in 1ppm, channel 2: relative humidity in 0.01%, channel 3: temperature in 0.01°C, channel 4:temperature in 0.01°F, channel 5: dew point temperature in 0.01°C, channel 6: dew point temperature in 0.01°F	R
30556 40556	Module reset status, 1: power-on, 2: watchdog, 3: software reset command Only for Modbus TCP protocol	R
40558	Ethernet host watchdog timeout value, 5 to 65535, in second, 0 to disable. Only for Modbus TCP protocol	R/W
30559 40559	Ethernet host watchdog timeout count. Only for Modbus TCP protocol	R
30560 40560	Module name, 0x0303 Only for Modbus TCP protocol	R
40564	TCP disconnection timeout value, 5 to 65535, in second, 0 to disable. Only for Modbus TCP protocol	R/W

40565	Module reset timeout value, 30 to 65535, in second, 0 to disable. Only for Modbus TCP protocol	R/W
40859	The time for displaying message, ranged from 1 to 65535 in seconds. 0 to display a message until a stop command received	R/W
40861	The index for a pre-saved message to display on the LCD screen, 0 ~ 19, -1(65535) to stop	R/W

Address	Description	Attribute
40865	RTC year, 2000 to 2159	R/W
40866	RTC month, 1 to 12	R/W
40867	RTC date, 1 to 31	R/W
40868	RTC hour, 0 to 23	R/W
40869	RTC minute, 0 to 59	R/W
40870	RTC second, 0 to 59	R/W
40871	Total number of log records, low word	R
40872	Total number of log records, high word	R
40873	The starting record to read log data, low word	R/W
40874	The starting record to read log data, high word	R/W
40875	The status of the data logging, 0: stopped, 1: running	R
40876	The data logger command, 0: stop, 1: run, 2: run in period mode	R/W
40877	Continue writing when data logger is full, 0: no, 1: yes	R/W
40878	Hour of the data logger sampling period, 0 ~ 24	R/W
40879	Minute of the data logger sampling period, 0 ~ 59	R/W
40880	Second of the data logger sampling period, 0 ~ 59	R/W
40881	Starting year when logging in period mode, 2000 ~ 2159	R/W
40882	Starting month when logging in period mode, 1 ~ 12	R/W
40883	Starting date when logging in period mode, 1 ~ 31	R/W
40884	Starting hour when logging in period mode, 0 ~ 23	R/W
40885	Starting minute when logging in period mode, 0 ~ 59	R/W

Address	Description	Attribute
40886	Starting second when logging in period mode, 0 ~ 59	R/W
40887	Ending year when logging in period mode, 2000 ~ 2159	R/W
40888	Ending month when logging in period mode, 1 ~ 12	R/W
40889	Ending date when logging in period mode, 1 ~ 31	R/W
40890	Ending hour when logging in period mode, 0 ~ 23	R/W
40891	Ending minute when logging in period mode, 0 ~ 59	R/W
40892	Ending second when logging in period mode, 0 ~ 59	R/W
450302	Saves or shows message, by Modbus function 16 only. Refer to Q12 in section FAQ (page 75) for more information.	W
00001	Digital output value of channel 0	R/W
00129	Safe value of digital output channel 0	R/W
00161	Power on value of digital output channel 0	R/W
00227	Write 1 to reload default TCP settings Only for Modbus TCP protocol	W
00234	Write 1 to reboot module Only for Modbus TCP protocol	W
00257	RS-485 Protocol, 0: DCON, 1: Modbus RTU Only for Modbus RTU protocol	R/W

Address	Description	Attribute
00260	Modbus RTU host watchdog mode 0: same as I-7000 1: can use AO and DO command to clear host watchdog timeout status Only for Modbus RTU protocol	R/W
00261	RS-485 host watchdog mode, 1: enable, 0: disable. Only for Modbus RTU protocol	R/W
00262	Write 1 to play notification sound	W
00270	Host watch dog timeout status, write 1 to clear host watch dog timeout status Only for Modbus RTU protocol	R/W
00273	Reset status, 1: first read after powered on, 0: not the first read after powered on	R
00280	Write 1 to clear all high latched analog input values	W
00281	Write 1 to clear all low latched analog input values	W

00291 ~ 00295	Low alarm status of channel 2 to 6. Write 1 to clear low latched alarm. channel 2: relative humidity, channel 3: temperature in 0.01°C, channel 4:temperature in 0.01°F, channel 5: dew point temperature in 0.01°C, channel 6: dew point temperature in 0.01°F	R/W
00305 ~ 00311	High alarm status of channel 0 to 6. Write 1 to clear high latched alarm. channel 0: CO, channel 1: CO ₂ , channel 2: relative humidity, channel 3: temperature in 0.01°C, channel 4:temperature in 0.01°F, channel 5: dew point temperature in 0.01°C, channel 6: dew point temperature in 0.01°F	R/W
00321 ~ 00327	Enable/disable alarm of channel 0 to 6, write 0 to disable alarm; write 1 to enable alarm. channel 0: CO, channel 1: CO ₂ , channel 2: relative humidity, channel 3: temperature in 0.01°C, channel 4:temperature in 0.01°F, channel 5: dew point temperature in 0.01°C, channel 6: dew point temperature in 0.01°F	R/W
00337 ~ 00343	Alarm type, momentary or latched, of channel 0 to 6, write 0 to enable momentary alarm mode; write 1 to enable latched alarm mode. channel 0: CO, channel 1: CO ₂ , channel 2: relative humidity, channel 3: temperature in 0.01°C, channel 4:temperature in 0.01°F, channel 5: dew point temperature in 0.01°C, channel 6: dew point temperature in 0.01°F	R/W
00385 ~ 00391	Write 1 to clear high latched analog input value of channel 0 to 6 channel 0: CO,	W

	channel 1: CO ₂ , channel 2: relative humidity, channel 3: temperature in 0.01°C, channel 4:temperature in 0.01°F, channel 5: dew point temperature in 0.01°C, channel 6: dew point temperature in 0.01°F	
00417 ~ 00423	Write 1 to clear low latched analog input value of channel 0 to 6 channel 0: CO, channel 1: CO ₂ , channel 2: relative humidity, channel 3: temperature in 0.01°C, channel 4:temperature in 0.01°F, channel 5: dew point temperature in 0.01°C, channel 6: dew point temperature in 0.01°F	W

Revision History

Revision	Date	Description
1.0.0	2015/07	First released
1.1.0	2015/08	Added DL-301/DL-303/MQTT/Message information